

## INSTRUCTION MANUAL

### **Competition long jump and triple jump take-off board set with stainless steel foundation tray lowered edges and wooden base board**

**S-250 (ver. XI 2020)**



**SAFE JUMPS TECHNOLOGY**

File: 2022-06-10  
PRODUCT SUPPORT  
Paweł Ciechanowski  
[p.ciechanowski@polanik.com](mailto:p.ciechanowski@polanik.com)



## Thank you for choosing Polanik competition take-off board.

### Contents

Chapter	Page
I. General characteristics	2
II. Parts list (part sets)	3
III. Assembly and installation	4
IV. Remarks on maintenance and operating	8
V. Technical drawing - installed take-off board	9
VI. Additional equipment, available separately	10
VII. WA certificate	11

### I. General characteristics

The take-off board S-250 is designed for conducting sports events and training programs of horizontal jumps.

Main features of the take-off board:





- construction according to the latest safety recommendations – no metal elements in take-off zone, so foundation tray with lowered edges covered by synthetic surface and white take-off board fastened from the bottom side, no screws on top



- innovative construction – constituted by elements which are easy to assemble, transport and store
- easy operating – fast assembly and disassembly processes, which take 15 minutes approx., can be done by one person provided that the foundation tray is already embedded in the track,
- high durability and quality – foundation tray made of stainless steel does not require additional maintenance actions, other elements are made of plastic, waterproof plywood and impregnated wood, the take-off board meets the international quality standards
- fast replacement of wearing parts and elements

## II. Parts list (part sets)

Item	Part/set description	Q-ty pcs	Part/set sketch
1	Stainless steel foundation tray (lowered edges) with accessories for concreting (draining tubes and spacing boards) K3-250	1	
2	Wood base board S-250-01-01	1	
3	White take-off board with screws K1-250	1	
4	Indicator plasticine board 2020 model K8-250	2	
5	Training indicator board without plasticine S-250-02-03	1	
6	Plasticine 300 g S-250-02-01	1	

Item	Part/set description	Q-ty pcs	Part/set sketch
7	Plasticine forming knife 2020 model K9-250	1	
8	Tool set S-0250-ZM3-S-250 - wrench to block the supporting board in the tray - screwdriver to fasten white take-off board to base board	1	
		1	
9	Draining plastic grid S-250-03-00	3	

### III. Assembly and installation

The take-off board set is assembled for transport and includes all the mentioned elements. Before first use the foundation tray (item 1) is to be embedded in the track in the prescribed place, so that the take-off line – the edge of the white take-off board (item 3) which is closer to the landing pit, is in the distance of:

- 1 - 3 m (for long jump) to the landing pit edge that is closer to the take-off line – the WA international competition rules,
- 13 m (for men) and 11 m (for women) to the landing pit edge that is closer to the take-off line – the WA international competition rules.

For any other competition, the distance shall be adjusted to competitors` level.

The installation point of the tray (item 1) of the take-off board is presented below.

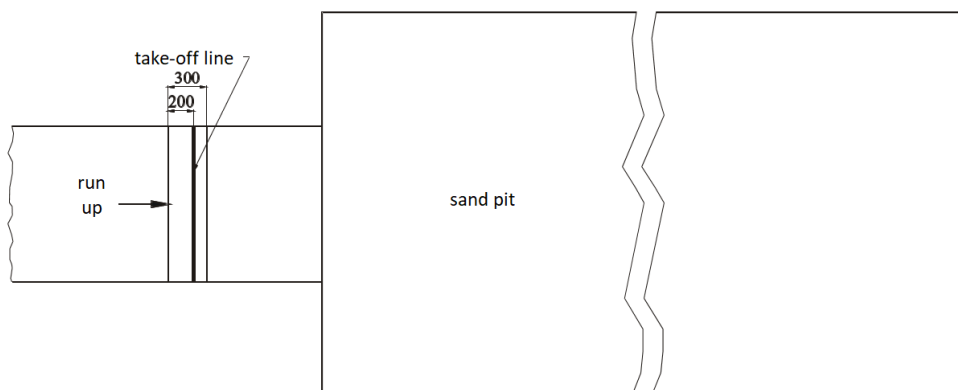

Drawing no. 1. Installing the take-off board – general view

**ATTENTION!**

The long side edges (B) of the foundation tray are 13 mm lower, they should be covered by synthetic surface. The short side edges (A) are to be flash with the top surface of the synthetic surface.

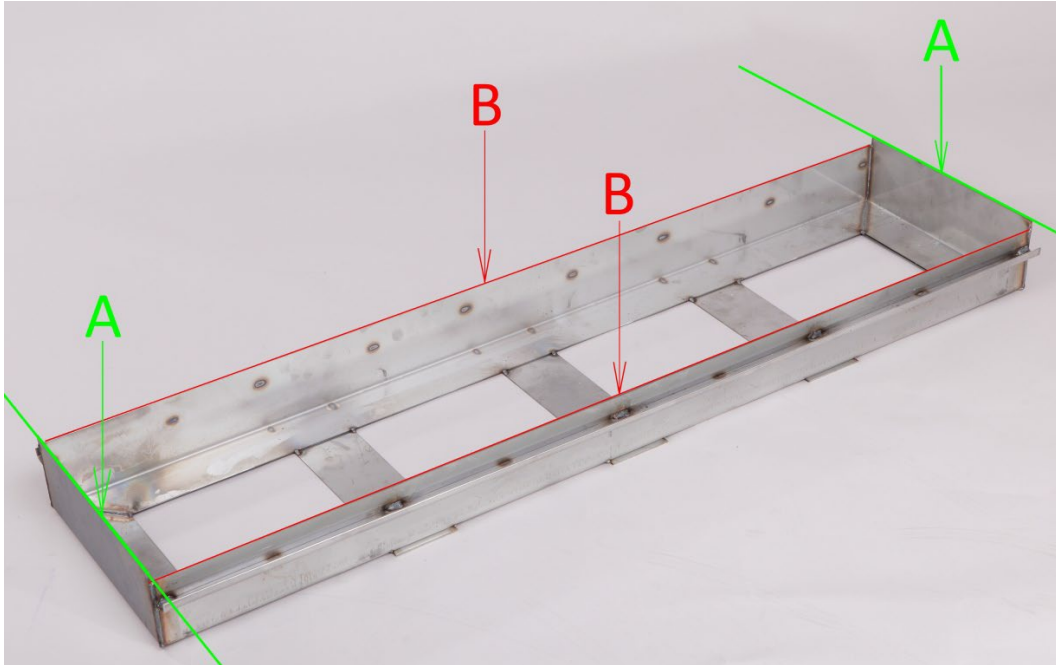

The tray should be positioned in the track and the inside of the tray must be secured with spacing boards (see image no. 1 and draw. no. 2), so that it does not deform while placing the concrete. Deformations can make the plasticine board (item 4) or training board (item 5) block inside the tray.



Image no. 1. Installed tray secured with spacing boards



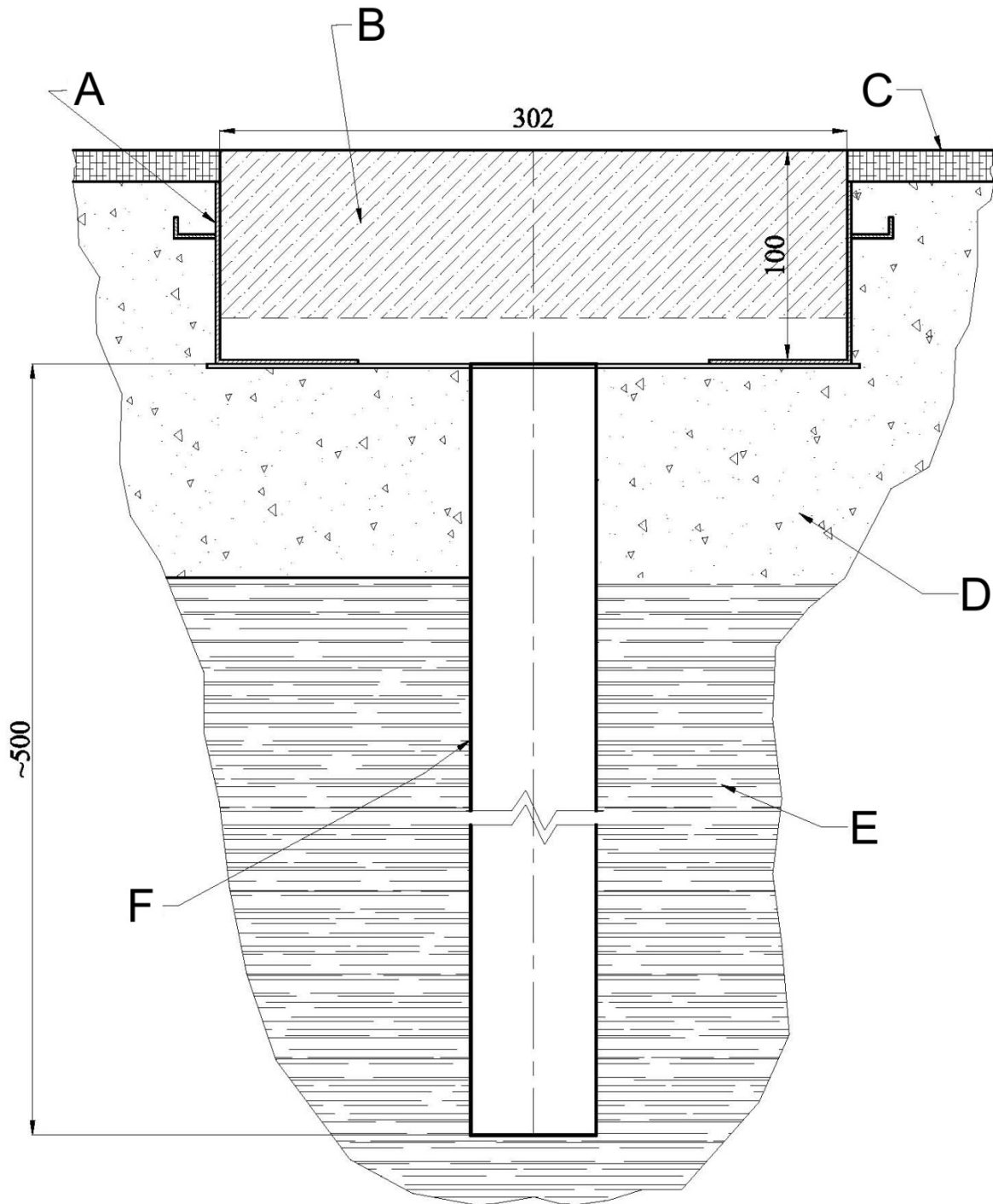

- |                     |                   |                                 |
|---------------------|-------------------|---------------------------------|
| A – foundation tray | B – spacing board | C – athletics synthetic surface |
| D – concrete        | E – ground        | F – draining tube               |

Drawing no. 2. Embedding the foundation tray

Draining tubes ought to be positioned vertically in the spaces of the foundation tray and should go past the concrete layer. During the embedding process of the tray (item 1), draining tubes can stick out over the foundation tray bottom. After the concrete setting, the sticking tube ends are to be cut off as close to the tray bottom as possible to ensure the correct water outflow.

To install the take-off board (item 2 and item 3) in the embedded tray (item 1), a flat wrench 24 (item 8) is needed.



The installation begins with placing the plastic grids (item 9) in the embedded tray (item 1).



Next the base board (item 2) with white take-off board (item 3) should be positioned on the plastic grids (item 9), so that the square heads of the adjusting bolts point the landing pit.



The base board (item 2) with white take-off board (item 3) is secured inside the tray (item 1) by means of the adjusting plastic bolts, use special wrench 24 included in the set (item 8). The bolts should be turned counterclockwise until the perceptible resistance occurs.

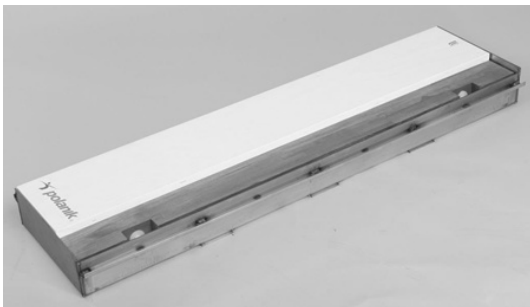

When the base board (item 2) with the white take-off board (item 3) are properly mounted,

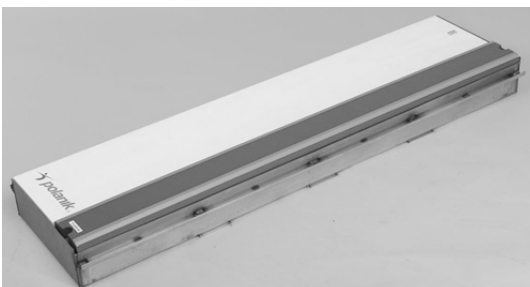

the indicator board (item 4 or item 5) can be put into the tray (item 1).

#### IV. Remarks on maintenance and operating

Plasticine strips deform during training sessions and competitions. There are two indicator plasticine boards (item 4), one training indicator board without plasticine (item 5), one plasticine block (item 6) and one forming knife (item 7) in the set. Thanks to the two indicator boards you are able to replace the one with the deformed plasticine strips with the other one very quickly. It is recommended that one should substitute plasticine board (item 4) with indicator board without plasticine (item 5) for intensive training sessions. Training indicator board (item 5) is thinner and does not require plasticine.

Dents and defects in the plasticine layers should be filled up and leveled. First one ought to apply thick layers of plasticine on the damaged areas. Then the layers are to be leveled with the forming knife (item 7), as it is shown below.



**Attention! While storing or using plasticine should be protected against high temperatures (over 40 °C), because otherwise it can change its shape and dimensions, and in extreme cases it can become a liquid.**

To ensure great aesthetics and high comfort for jumpers we use natural raw materials like wood and plywood. The materials are not so durable as synthetic ones. Thus the wooden take-off board parts wear out faster and they need to be replaced. In order to maintain the parts in good condition all the take-off board elements:

- the base board (item 2) with white take-off board (item 3),
- the plasticine indicator board (item 4) (or training indicator board (item 5))
- plastic grid (item 9)

must be removed from the embedded tray after competitions and training sessions and stored in a dry place. It is recommended that the embedded stainless steel tray (item 1) should be sheltered with the stainless steel cover (available separately). Any defects in paint coating revealed during thorough regular inspections of the board set must be repaired with wood paint or impregnant.

**Even though the wooden elements are impregnated and protected with paint, a prolonged contact with water can devastate or deform them.**

The white take-off board (item 3) can be unscrewed, turned over and screwed again to the base board (item 2). That prolongs significantly the product's life.

Even the best technical solutions cannot substitute for common sense. The usage of the product must take place under the supervision of qualified sports arena staff and trainers. The producer shall not be liable for any incidents caused by the improper take-off board installation, assembly or its misuse.





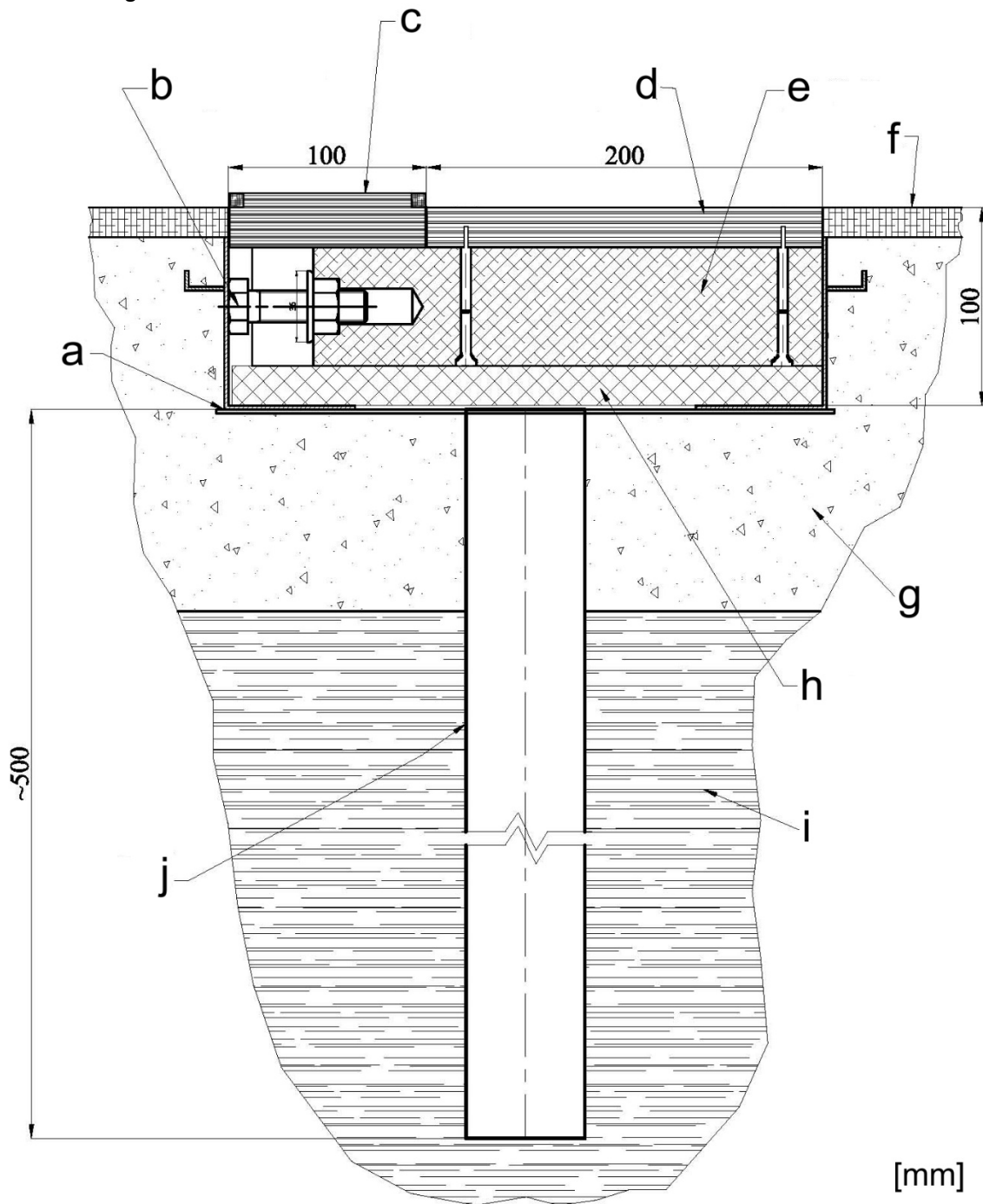

### V. Technical drawing - installed take-off board

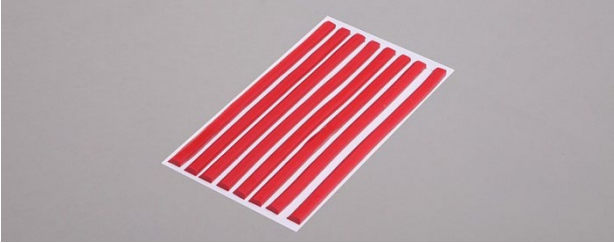

- a – stainless steel tray (item 1)
- b – adjusting bolt
- c – plasticine indicator board (item 4)
- d – white take-off board (item 3)
- e – wooden base board (item 2)
- f – athletics synthetic surface
- g – concrete
- h – plastic grid (item 9)
- i – ground
- j – draining tube

#### VI. Additional equipment, available separately

Item	Part/set description	Part/set sketch
1	<p>Stainless steel cover for competition take-off board PBN-S0250</p> <p>Stainless steel cover for take-off competition boards, secures the inside of the board tray, smooth surface and 6 adjustable feet (in the range of 20 mm) for installing synthetic track, strong ribbed construction. Designed for sticking tartan.</p>	
2	<p>Stainless steel cover with edges for competition take-off board PBN14-S0250</p> <p>Stainless steel cover for take-off competition boards, secures the inside of the board tray, special edges for installing synthetic surface, 6 adjustable feet (in the range of 20 mm), strong ribbed construction, equipped with edges to facilitate application of tartan.</p>	
3	<p>Plasticine straps for indicator board 2020 model P8x31-2020</p> <p>Set of 8 red plasticine straps, specially shaped, ready to be put into the indicator board recess, designed for Polanik competition take-off boards</p>	
4	<p>Rubber indicator board for competition board LG15-250</p> <p>black full rubber indicator board designed for training</p>	

## VII. WA certificate



# PRODUCT CERTIFICATE

World Athletics is pleased to certify that the following product meets all the technical requirements of the World Athletics Rules for the relevant competitions.

Product's Trade Name:

**Fixed equipment - Take-off board Competition**

Description, Colour/Absolute Thickness:

**Wood/plywood, White/dark blue**

Company Name, Country:

**Polanik Sp. z o. o. - Sp. K., POL**

Catalogue Number:

**S-250**

Certification Number:

**E-06-0433**

Test Report by and on:

-

Notes:

-

Date of Issue:

**1 June 2022**

Date of Expiry:

**June 2026**

Issued in accordance with the terms and conditions of the  
World Athletics Certification System



**Jon Ridgeon**  
World Athletics CEO

