

USER MANUAL Self-assembly garages for HJ landing areas

GW



Thank you for choosing Polanik garages.

Safe assembly and use

- Before you start to assemble and use the garage please read this manual carefully and store the manual in a safe place for further reference. Polanik shall not be liable for any damages which are the result of the failure to follow this manual.
- Unauthorized copying of this manual, in whole or in part, is prohibited.
- The contents of this manual are subject to change without notice.
- Specific warranty terms:

Failure to follow the below restrictions results in the loss of the warranty rights:

-do not climb the garage,

-do not walk or jump on the garage roof,

-do not sit on the garage roof,

-do not put anything on the garage,

-remove regularly any remaining snow from the garage roof,

-while manoeuvring the garage do not make any sudden movements and let castoring wheels adjust to the direction smoothly – otherwise dynamic turning of castoring wheel in one spot may damage synthetic track surface.

I. General description and use

The garage is designed to protect the landing area which is placed on the platform and sheltered with the waterproof cover outdoors. Main features:

The number of the mobile segments depends upon the volume of the landing area. The garage for the high jump area consists of two mobile segments and the garages for the pole vault landing area consists of three mobile segments.

The spacious structure ensures a proper clear space between the inside construction and the landing area, what minimizes the risk of damages while opening and closing the garage.



Each garage segment comes with build-in castoring wheels equipped with height adjustment and swivel lock. Furthermore it has got special handles for easy manoeuvring.



The mobile segments are linked with padlock clams.



Each mobile segment is equipped with rubber gaskets which seal the inside of the garage after closing the padlock clams.

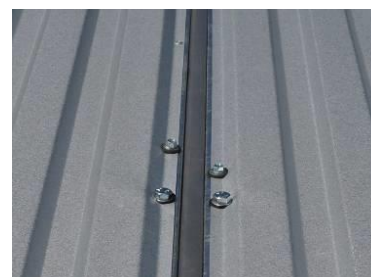
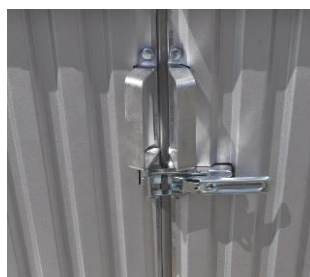

The garage bottom parts are equipped with PCV flaps to protect inside against small animals.



Special pads made of polyethylene foam on the roof edges protect against injuries from accidental collisions with the garage.



The garage sloped roof assures free water and snow outflow.



The supporting galvanized structure is made of high class welded steel profiles 30x30x2mm carefully manufactured that provides long lasting product life.



The garage elements are screwed together with metric screws only, without riveting or welding.



II. Technical specification

Product code	GW
Selling unit	square metre
Number of mobile segments	2
Mobile segment fittings	4 plastic wide castoring wheels with height adjustment and swivel lock, 4 handles, 4 padlock clams, pas bottom PCW pad against small animals
Roof	sloped, covered with 0,5 mm trapezoidal, aluminium and zinc sheets fastened with screws and rubber washers, garage edge safety PCW pads
Sides	0,5 mm trapezoidal, aluminium and zinc sheets
Supporting structure	steel galvanized profiles 30 x 30 x 2 mm
Inside dimensions [m]	6,30 x 4,30 dedicated for W-647
	6,30 x 3,30 dedicated for W-636 and W-636-B
	5,30 x 3,30 dedicated for W-536 and W-536-B
	4 x 3 dedicated for W-435
Weight [kg] 1 m²	40

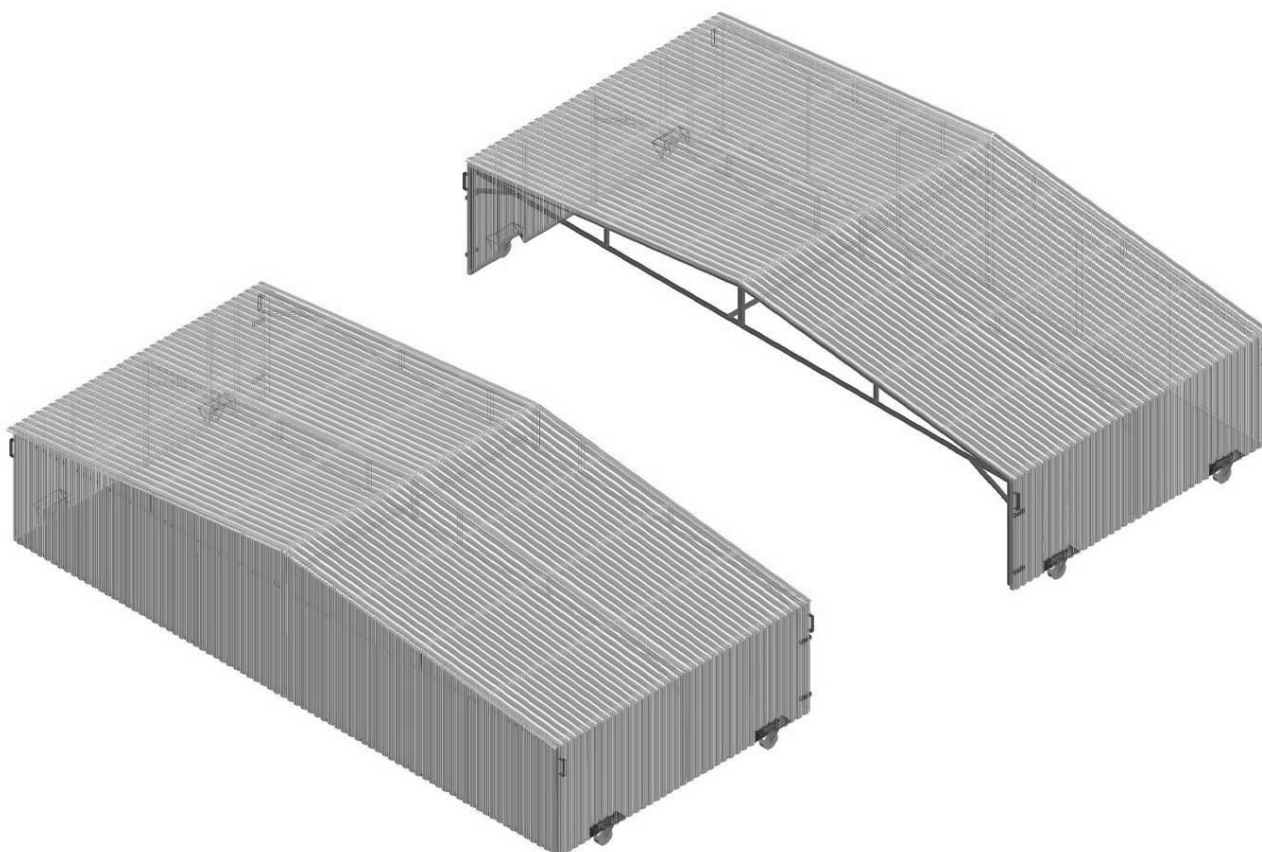

III. Declaration

1) No. 2015-12-21

2) Issuer's name: POLANIK

Issuer's address: Życzliwa 11, 97-300 Piotrków Tryb.

3) Objects of declaration

No.	Name	Code
1	Self-assembly garage for HJ landing area	GW

4) Technical specification described above is in accordance with the factory's internal engineering standards.

Additional Information

5) Declaration for:

Buyer/Distributor/User

Signed for and in behalf of:

POLANIK
2015-12-21 Piotrków Tryb.
(Date and place of issue)

6) Pawel Ciechanowski
Product Manager

.....
(Name, function)



.....
(Signature or equivalent authorized by the issuer)

IV. Packing and transport

The garage is delivered in parts to be assembled on site.

V. Operation and maintenance

The garage which is always parked in one place for longer times may cause slight recesses in synthetic surface due to weather conditions (high temperatures during summer and low during winter) that is normal wear and tear. The garage protects the landing area provided that the landing area is always sheltered with the waterproof cover and positioned on the platform which provides a proper isolation from the ground.

How to manoeuvre the mobile garage segments:

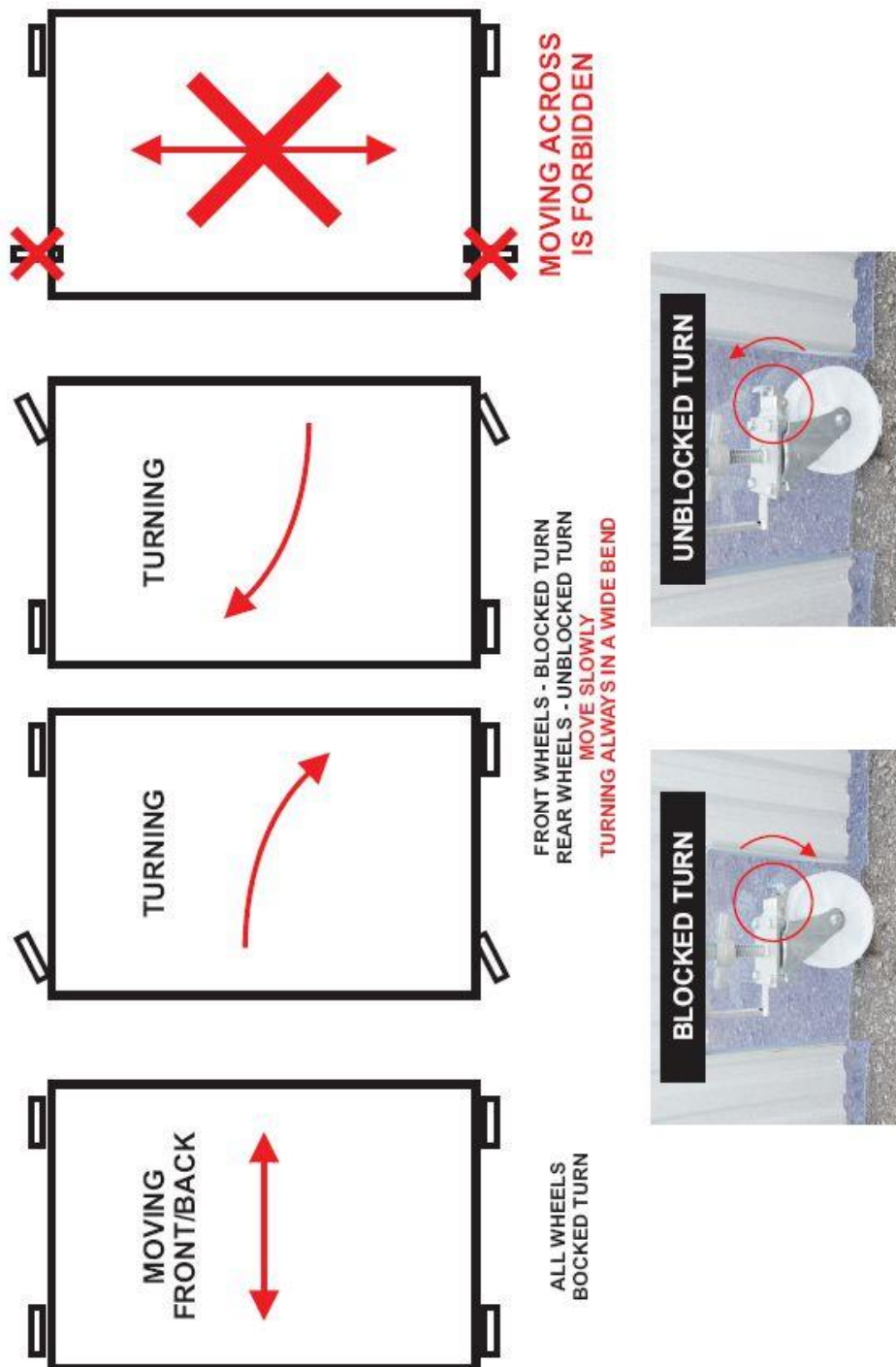

VI. Parts list

Item	Description	Quantity pcs
A1	Side wall with wheels	1
A2	Side wall with wheels	1
A3	Side wall with wheels and seal	1
A4	Side wall with wheels and seal	1
B1	Rear wall	1
B2	Rear wall	1
B3	Rear wall	1
B4	Rear wall	1
C1	Frame	6
C2	Frame	2
C3	Crossbeam	2
C4	Sealing catch	1
D1	Roof slope with seal and safety pad	1
D2	Roof slope with seal	1
E1	Roof slope with seal and safety pad	1
E2	Roof slope with seal	1
D3	Roof slope with safety pad	1
D4	Roof slope	1
E3	Roof slope with safety pad	1
E4	Roof slope	1
G1	Ridge tile	1
G2	Ridge tile	1
G3	Roof work	1
G4	Roof work	1
G5	Roof work	1
G6	Roof work	1
Screws M10x80 to assemble the supporting construction		
Screws M8x80 to fasten the roof slope		
Screws M6x16 to fasten the ridge tiles and the roof work		

VII. Assembly

To be sure that all the elements fit each other the garage is assembled and disassembled before it leaves the plant. The stages of the assembly are presented in the following drawings. Please start the assembly with the mobile segment marked red on the drawings.

Attention! At the first stage of the assembly all the screws should be installed only with hands, do not use spanners. When all the parts of the garage are completely assembled you can firmly screw down all the screws with spanners and fasten the ridge tiles.

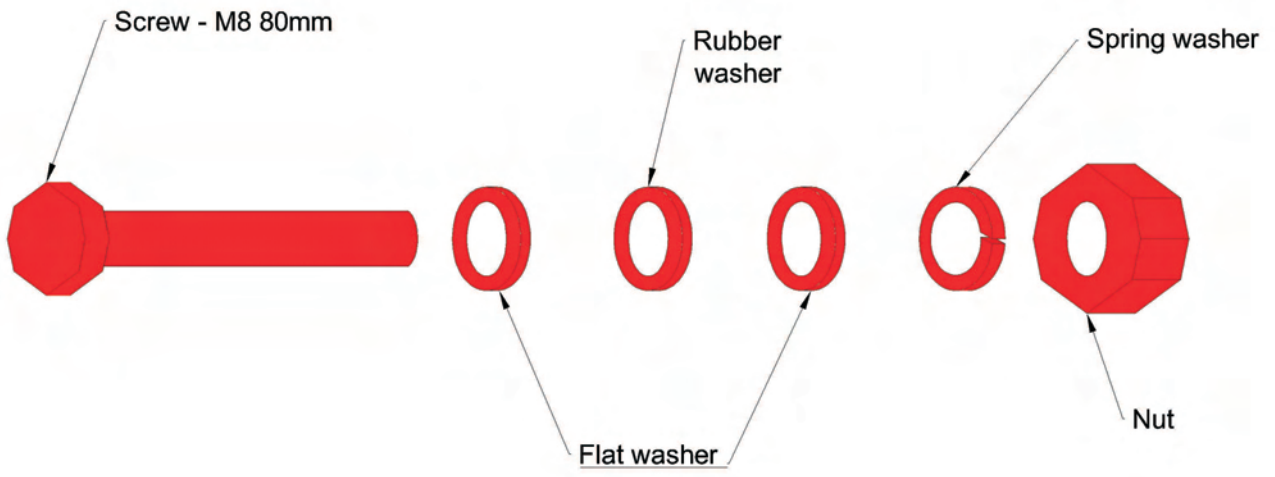

1

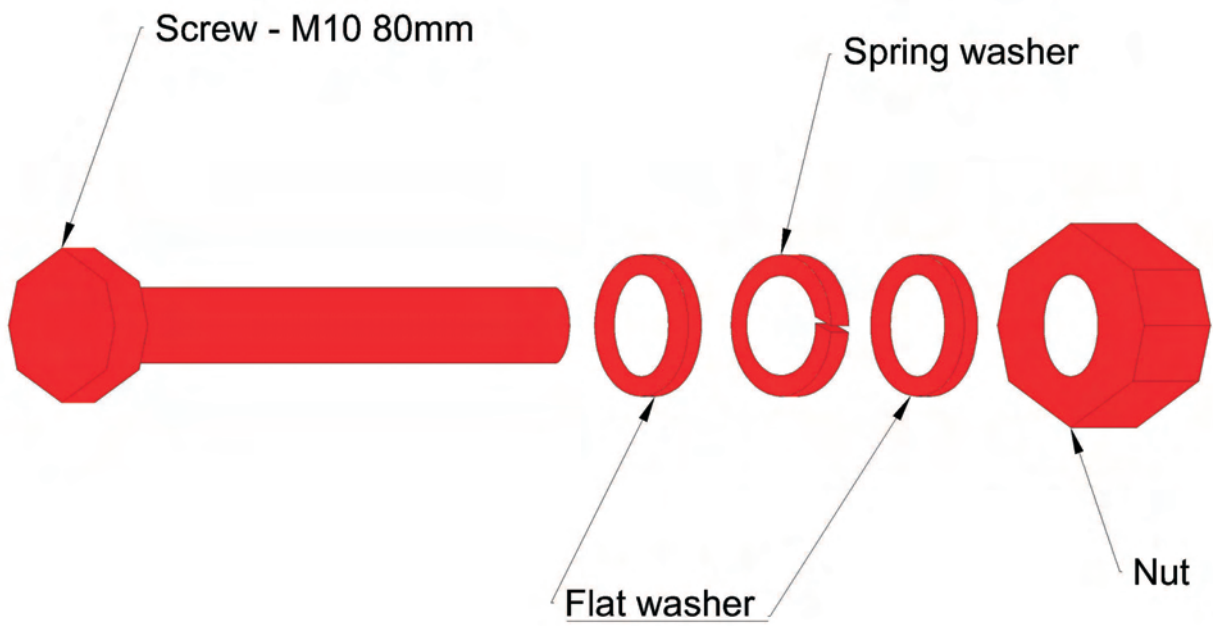

2

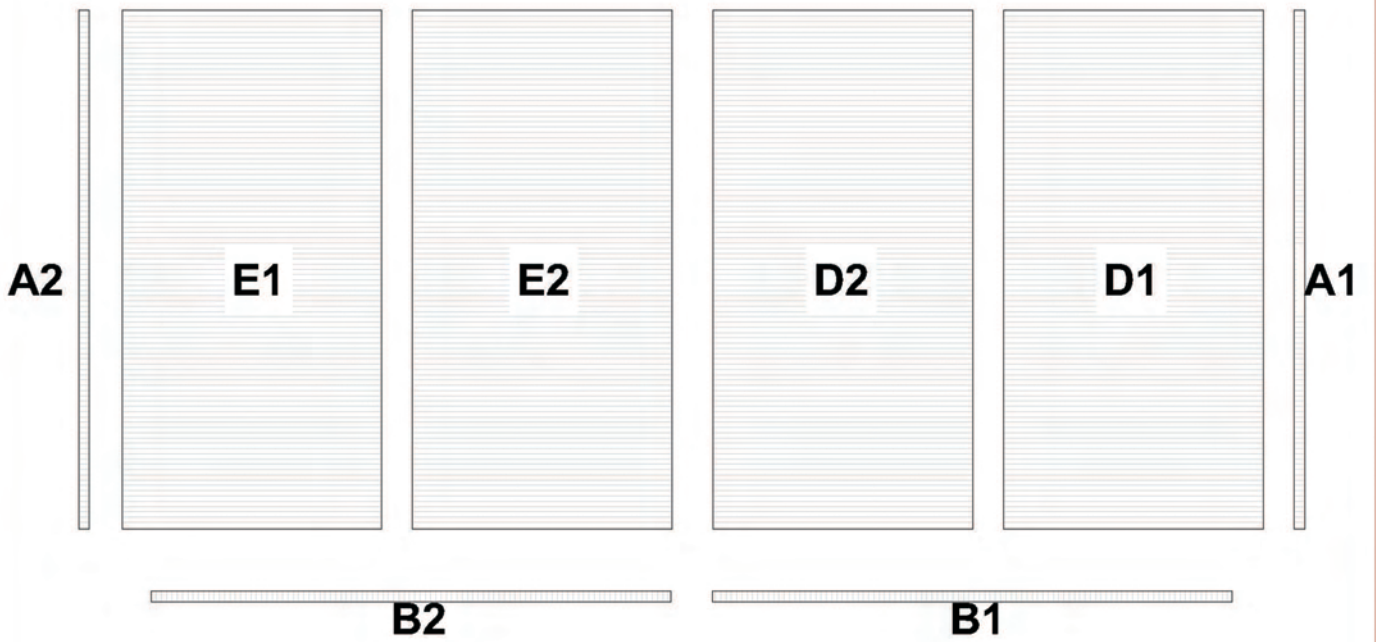
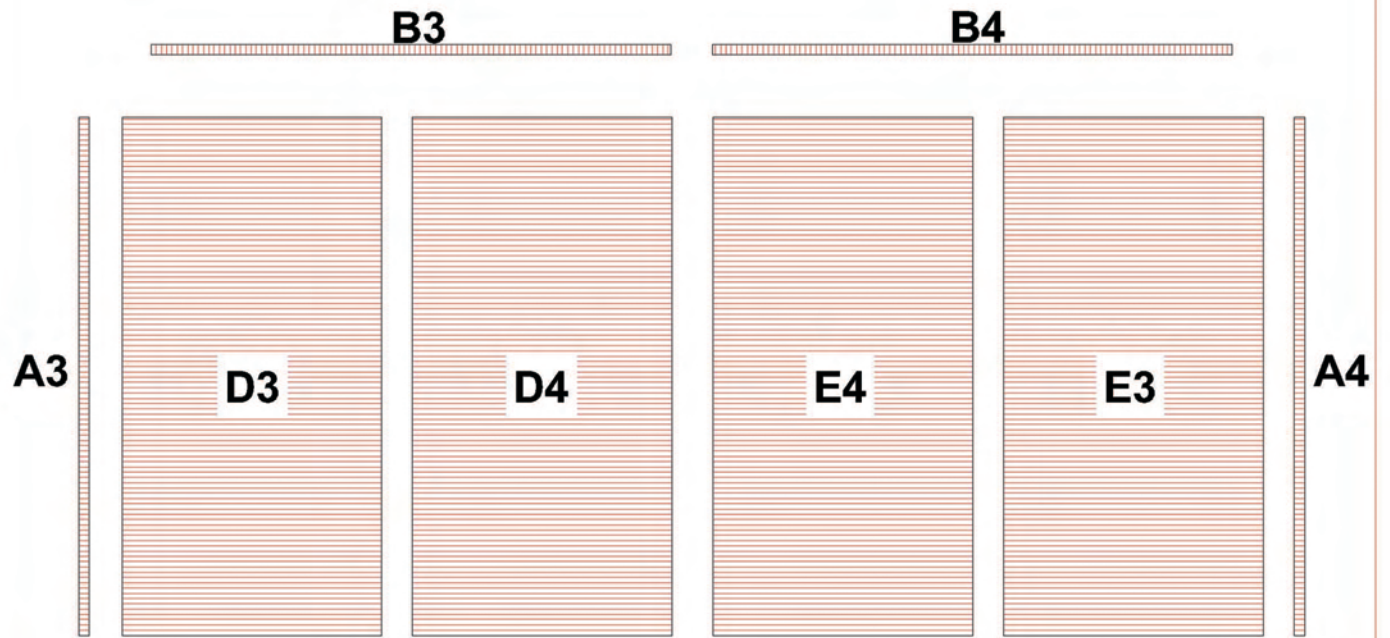

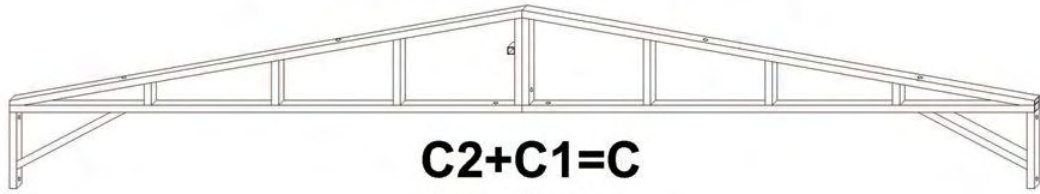
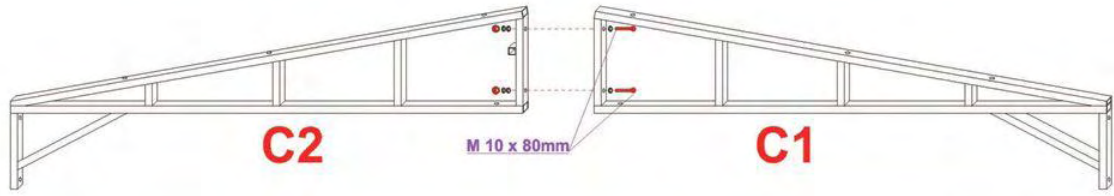

C2+C1=C
C = 2 pcs



C3=1 pc



C4=1 pc

4

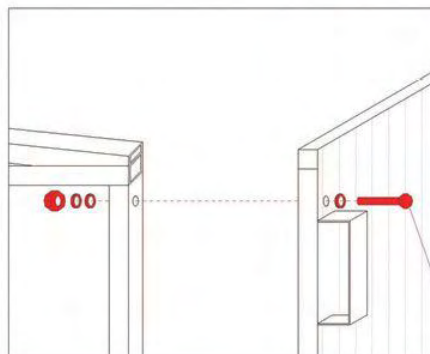

5

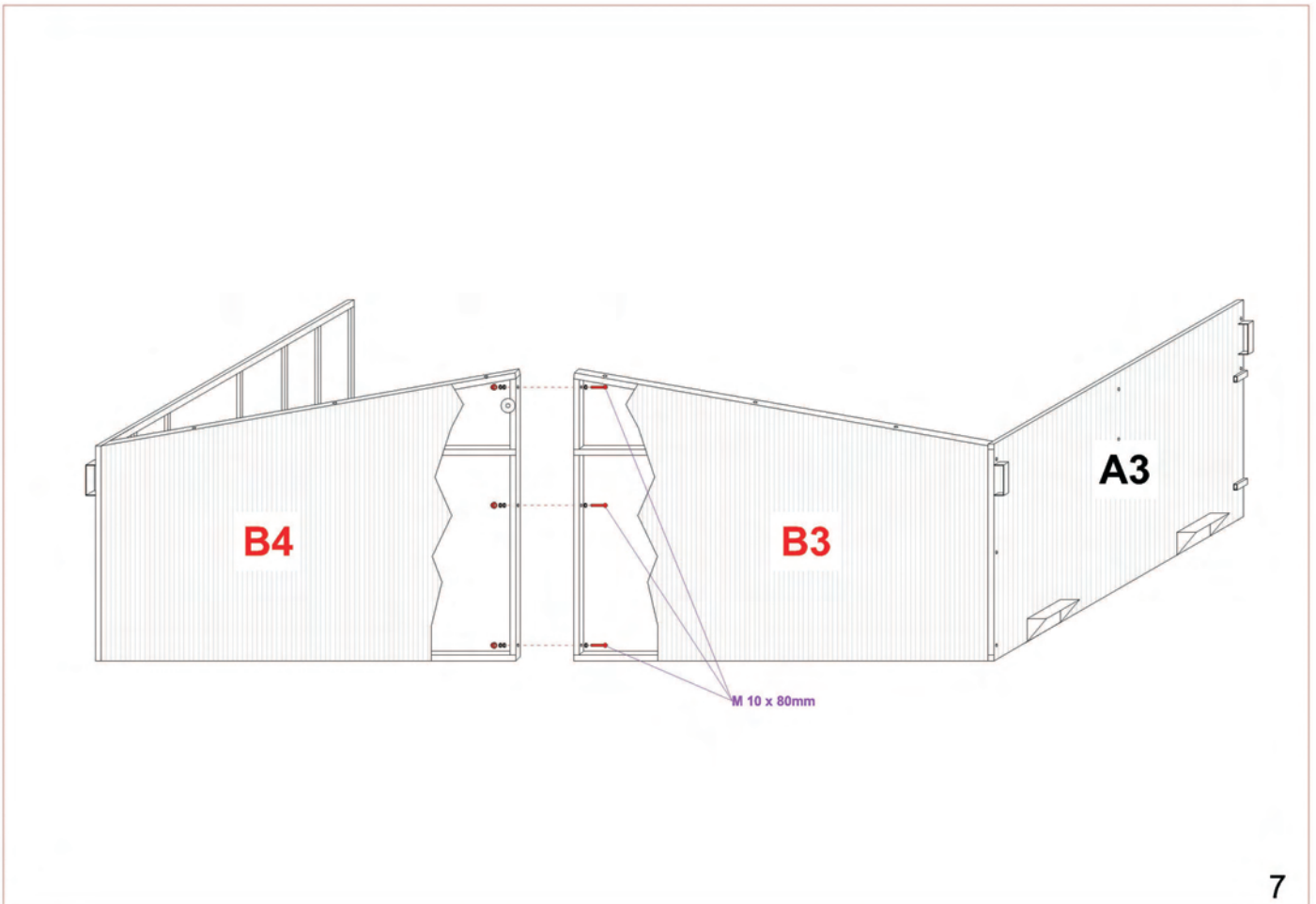
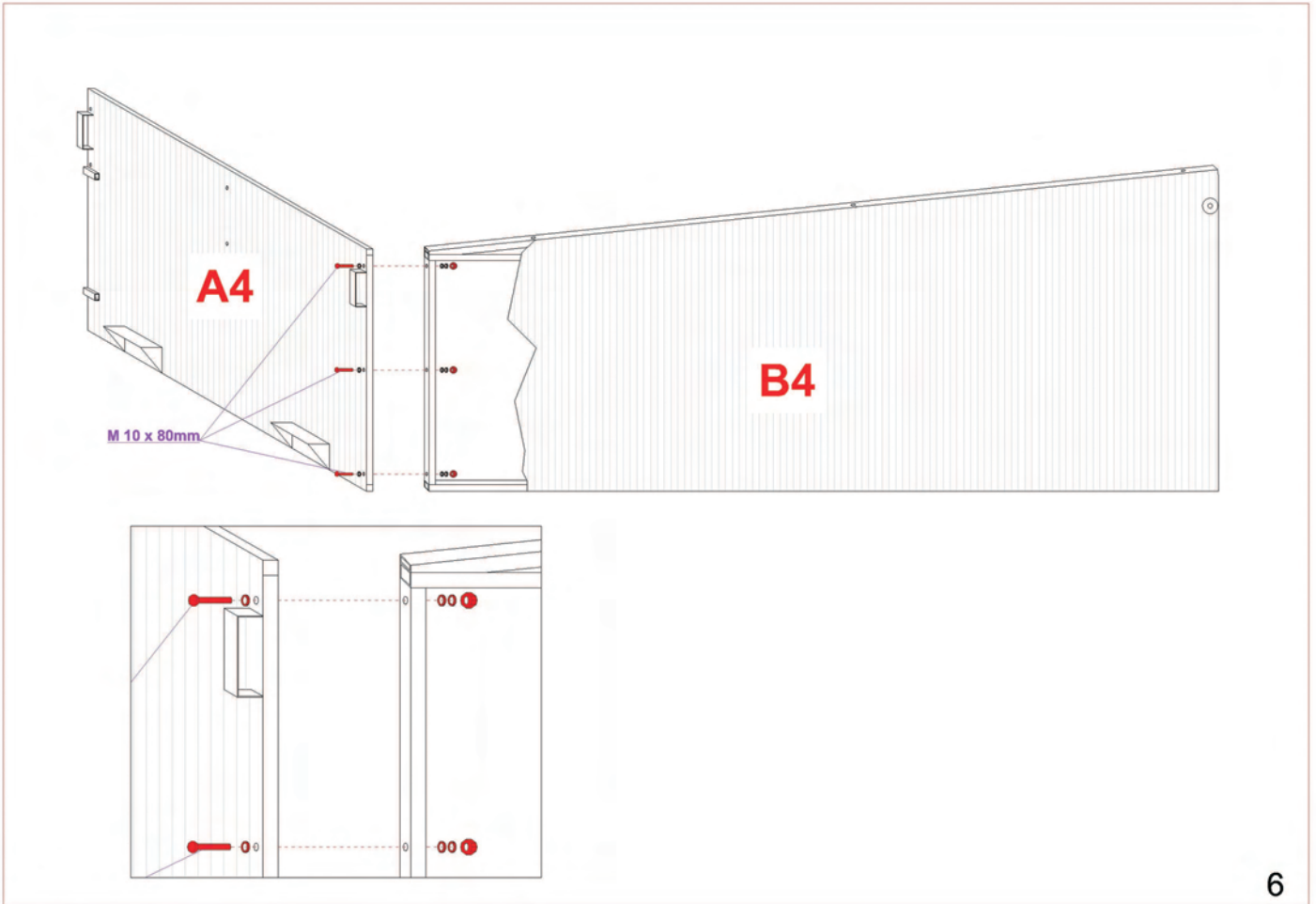

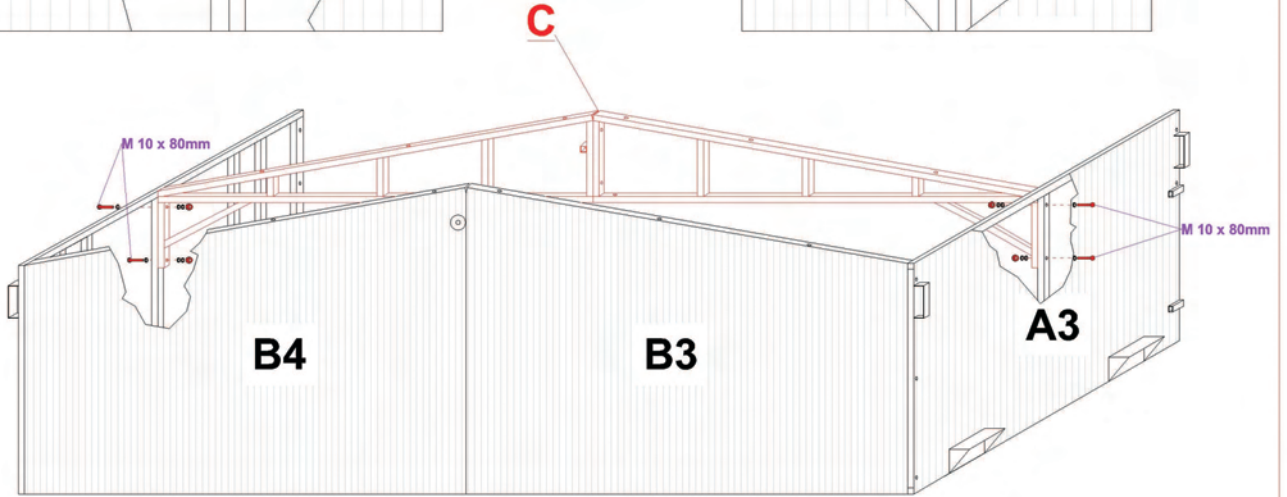
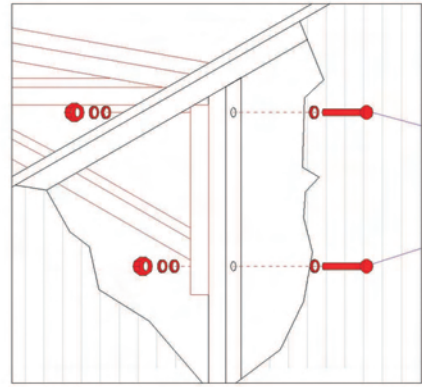
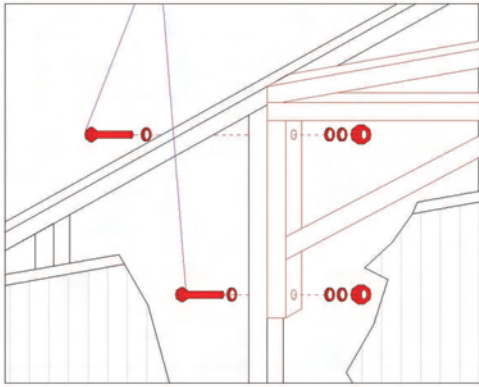

8

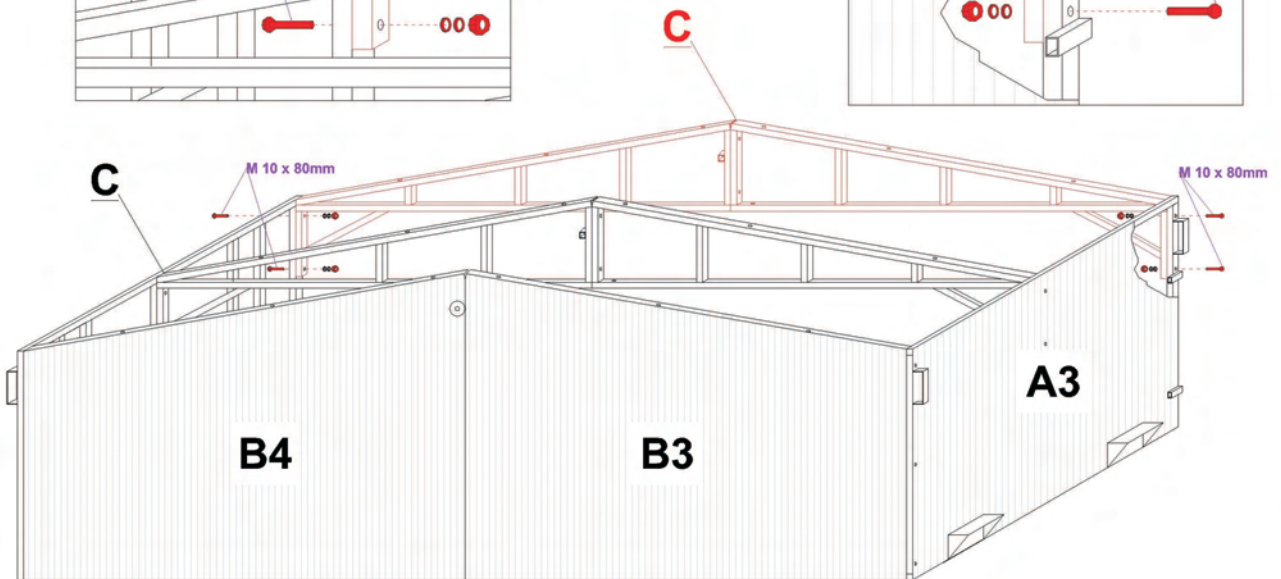
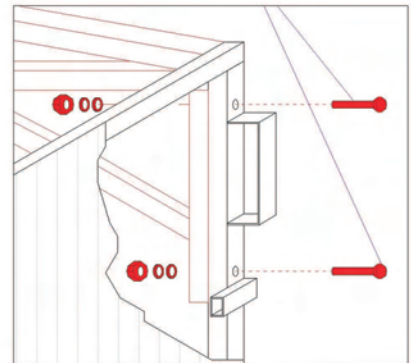
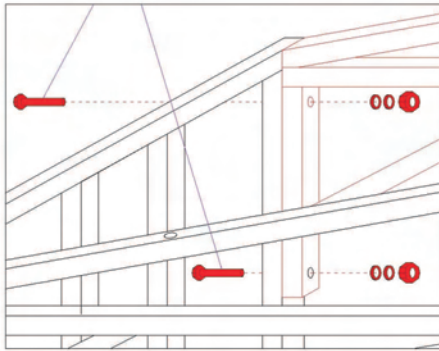

9

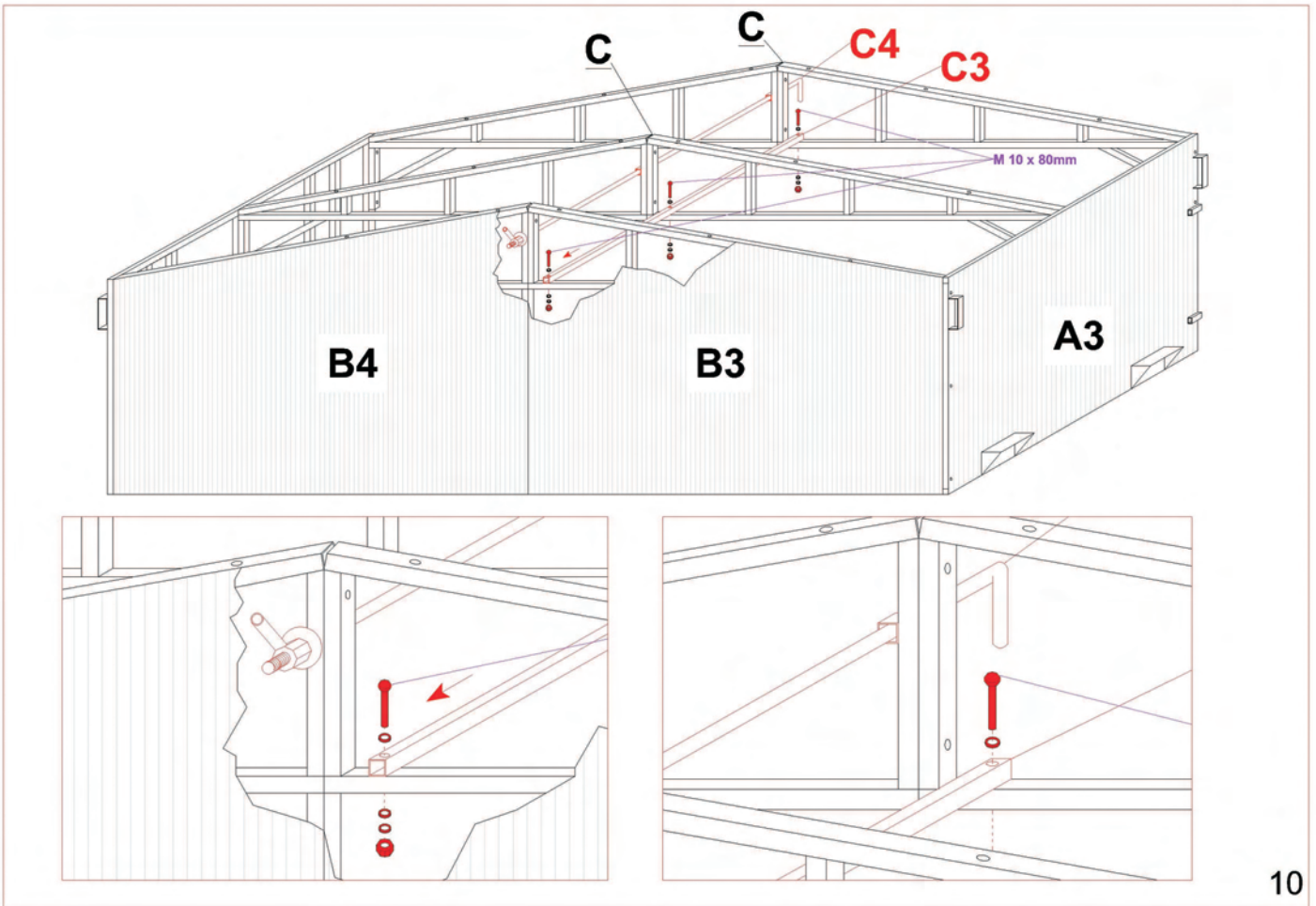

10

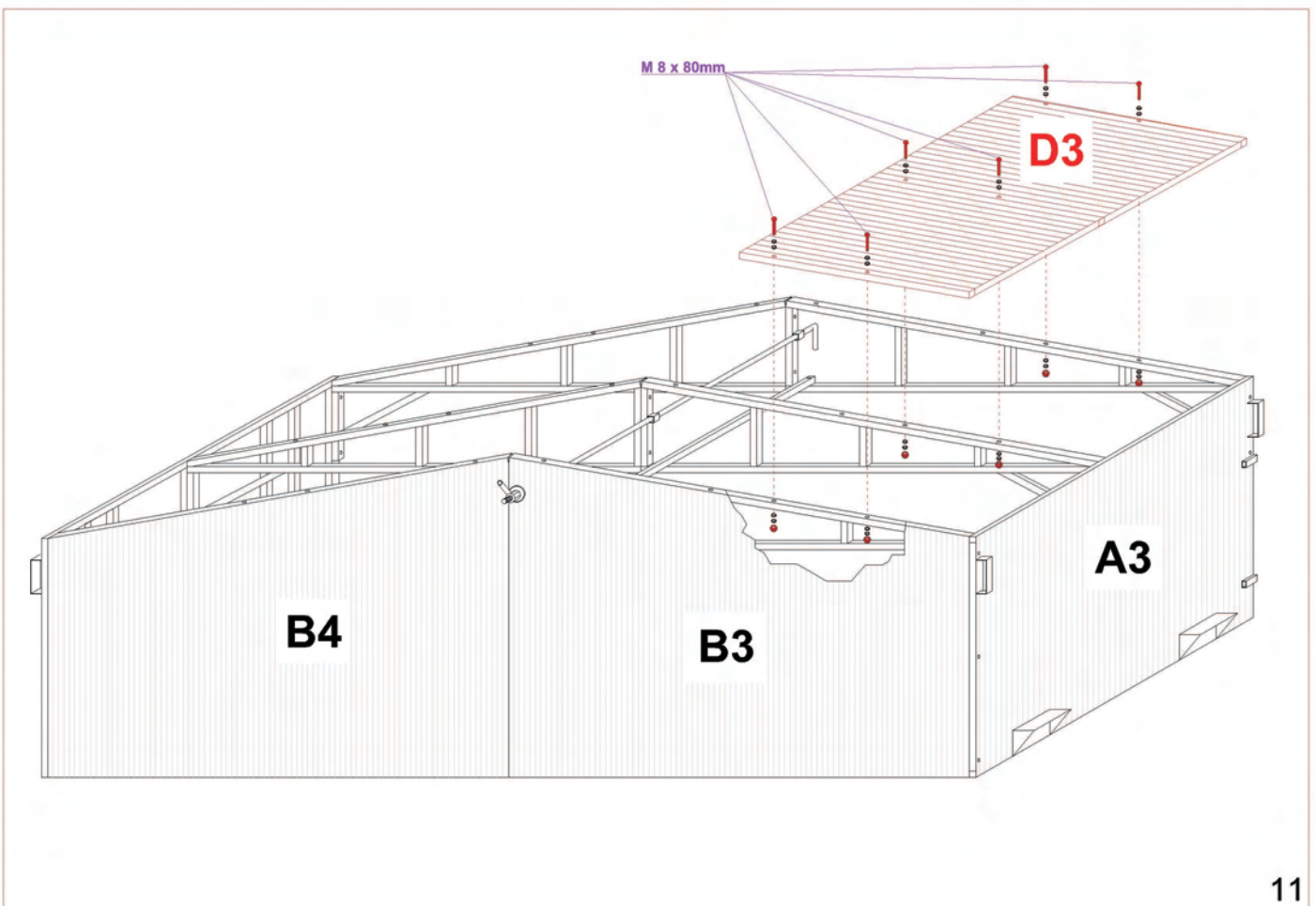

11

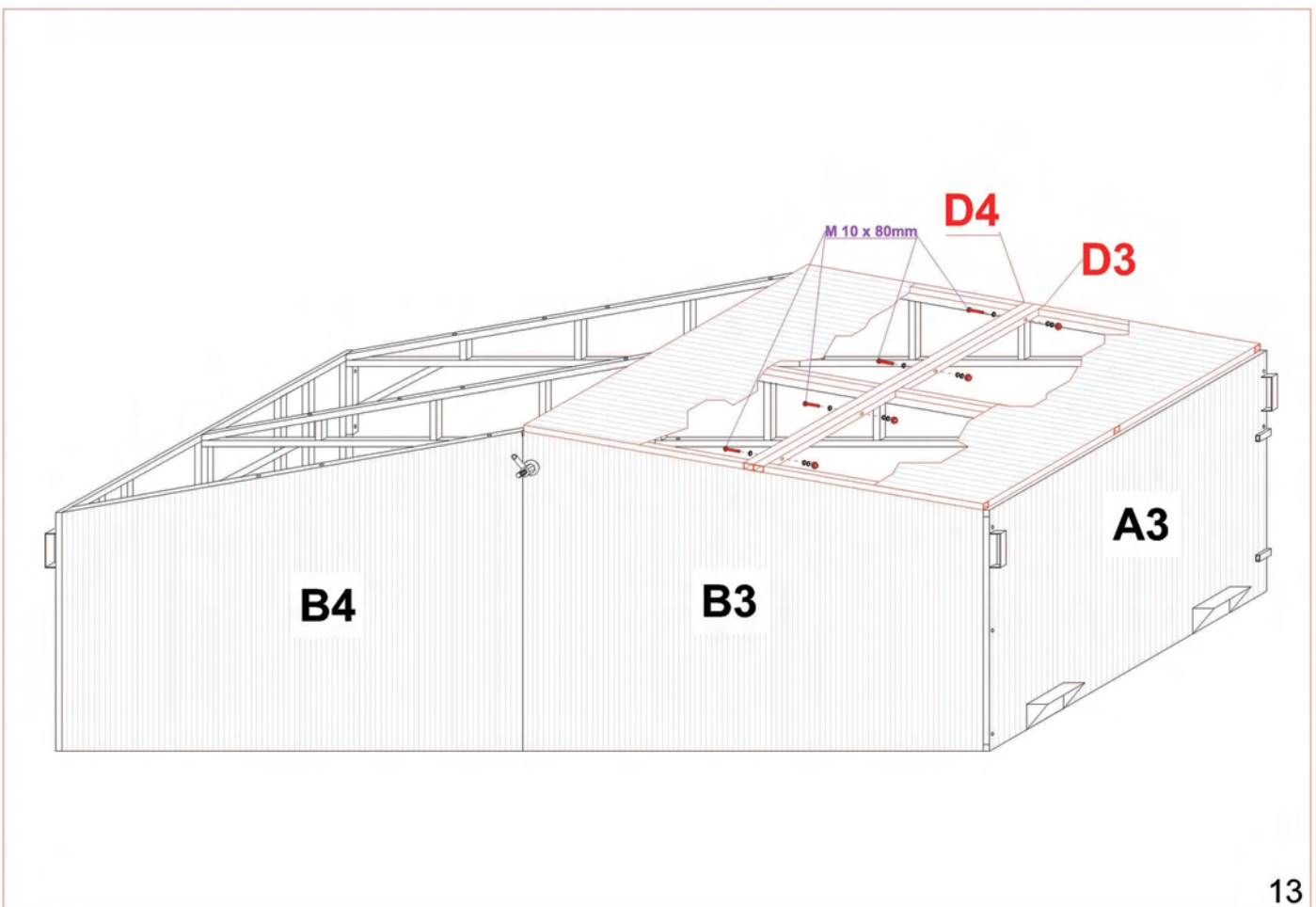
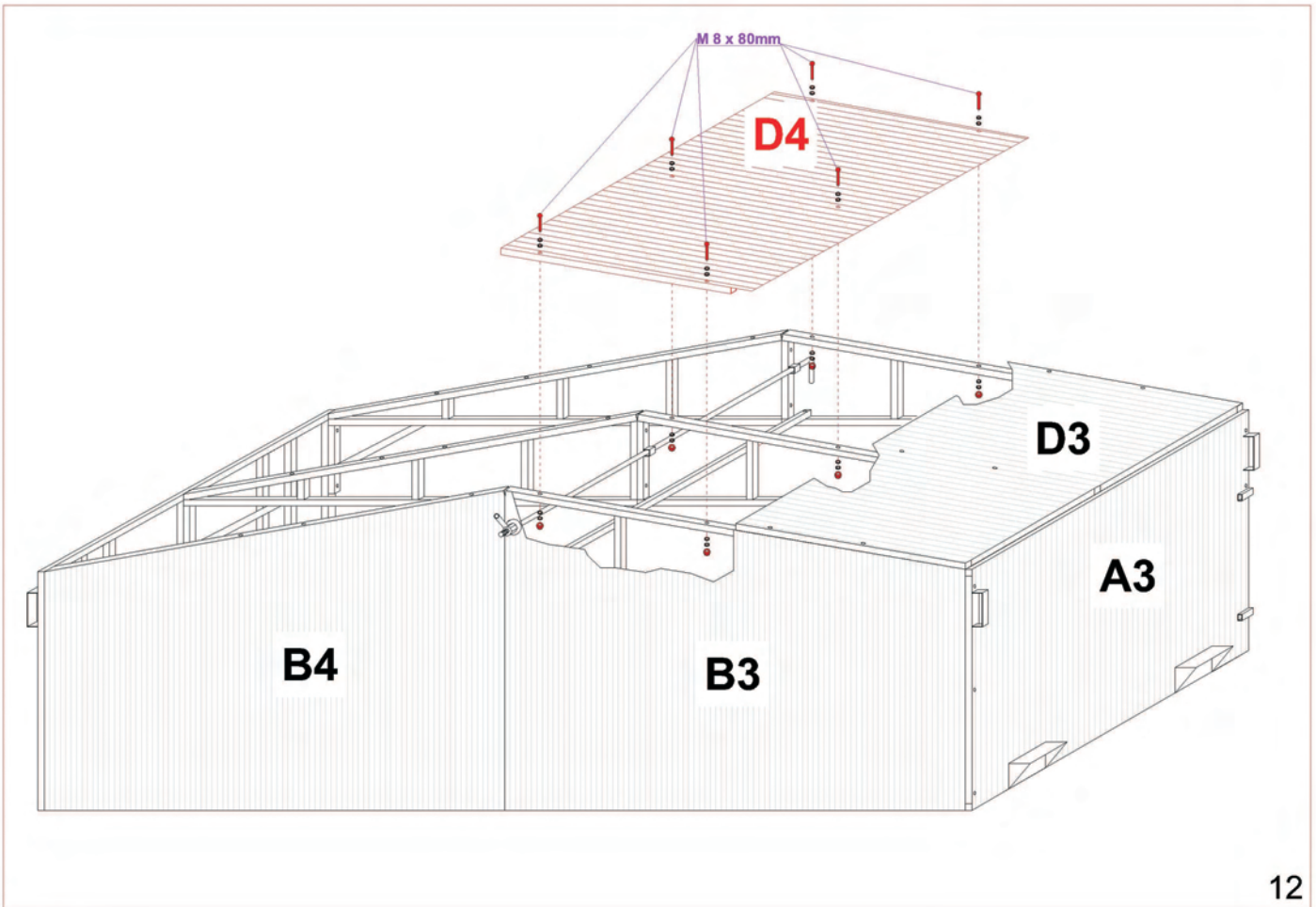

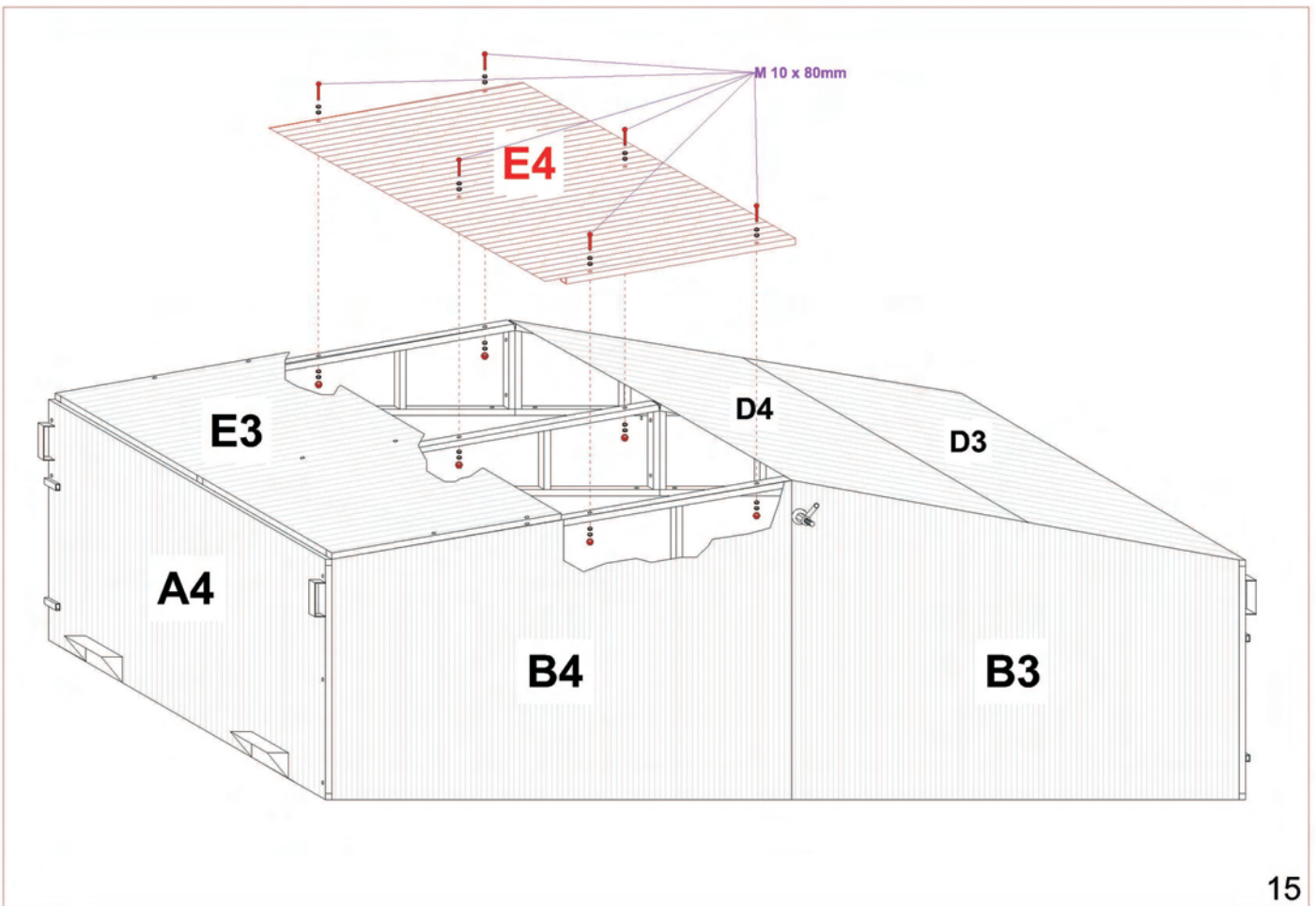
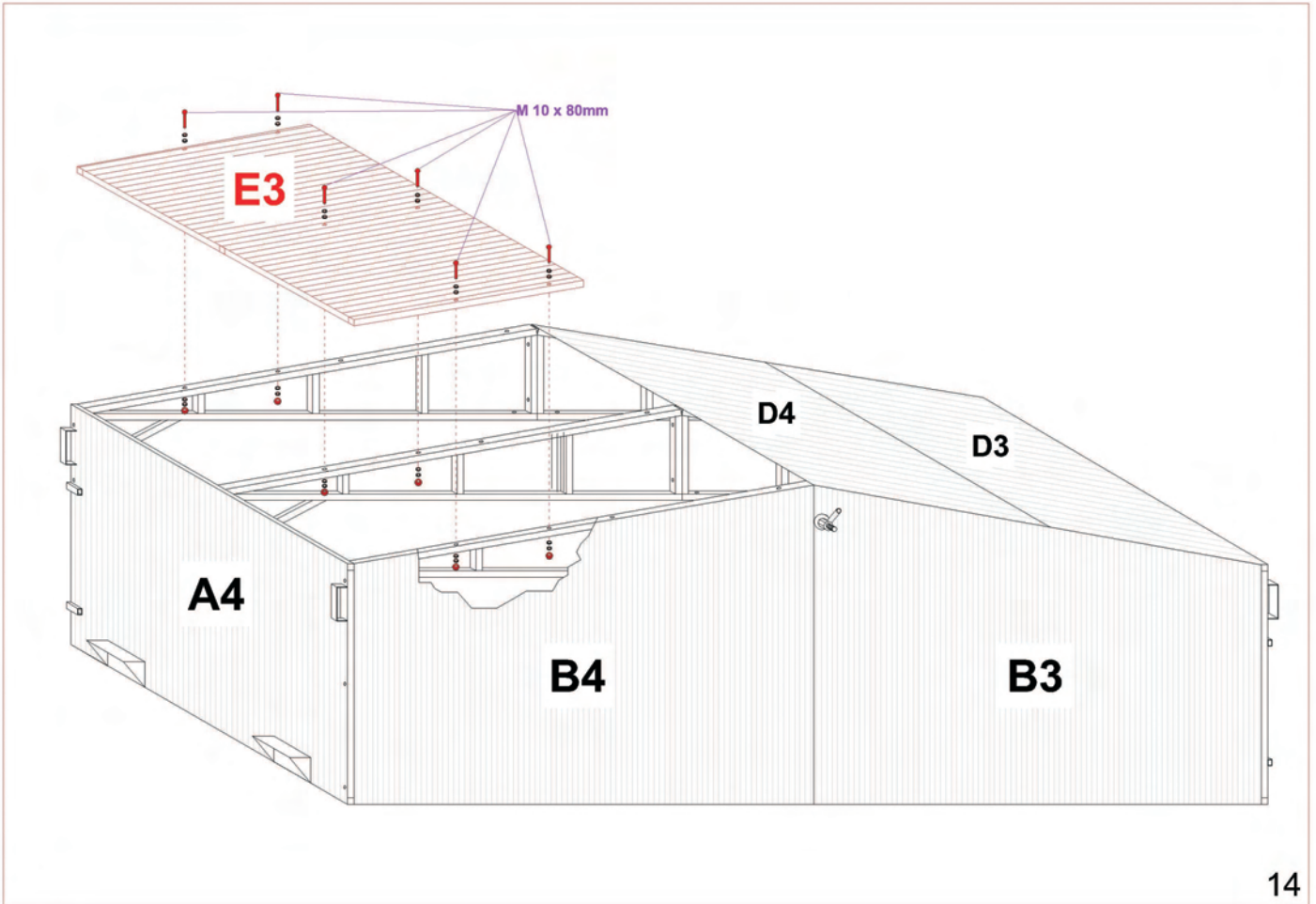

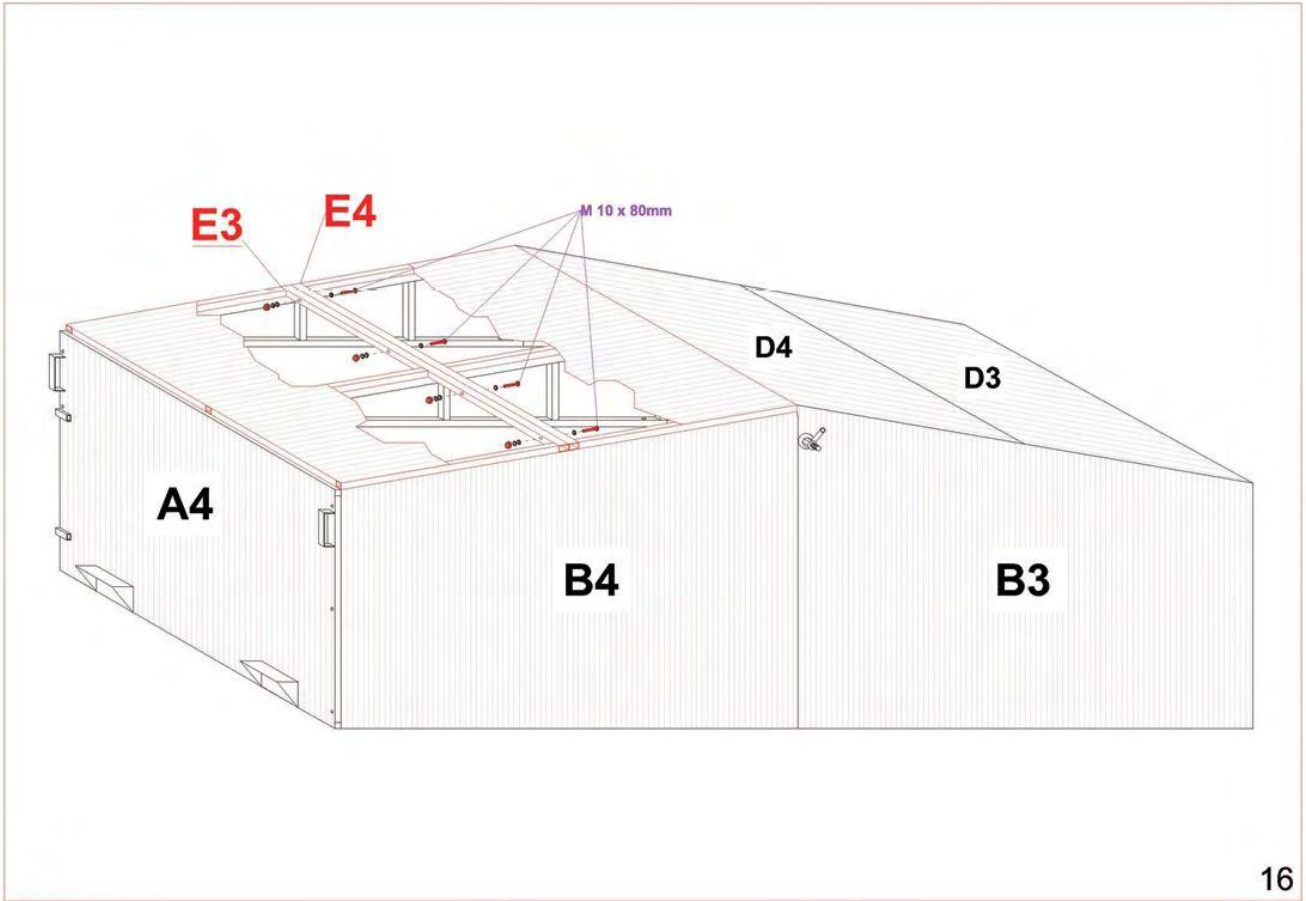

16

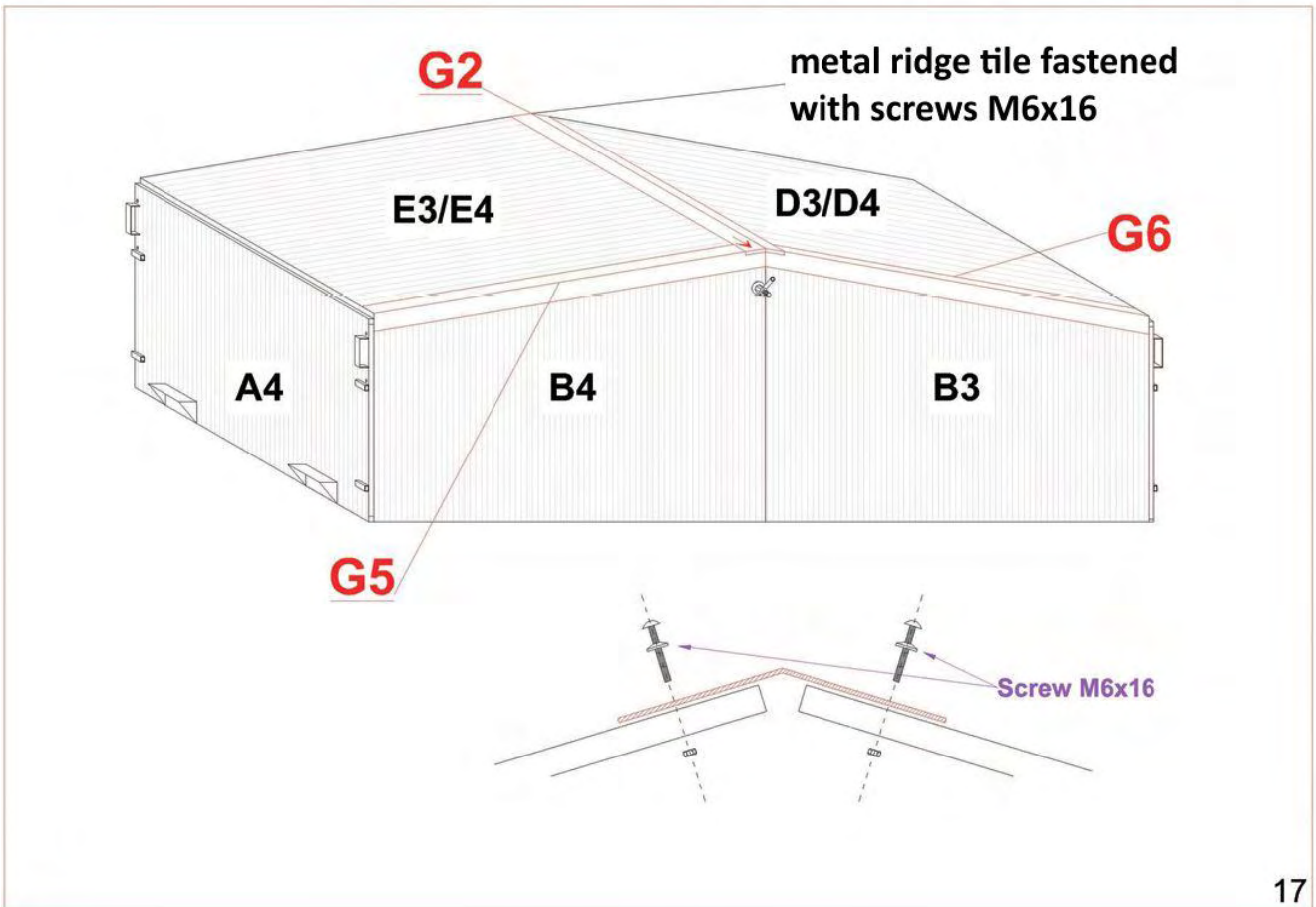

17

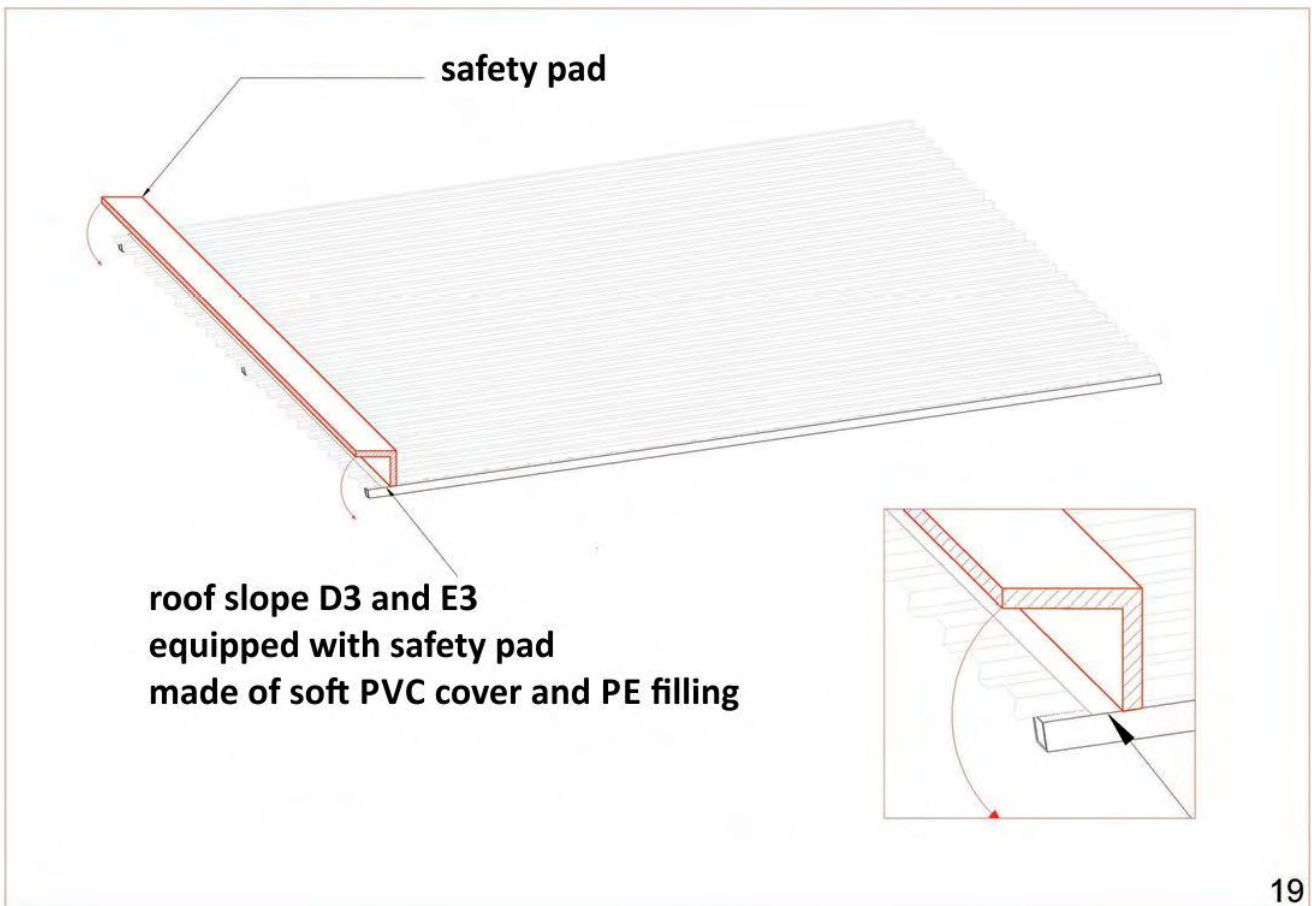
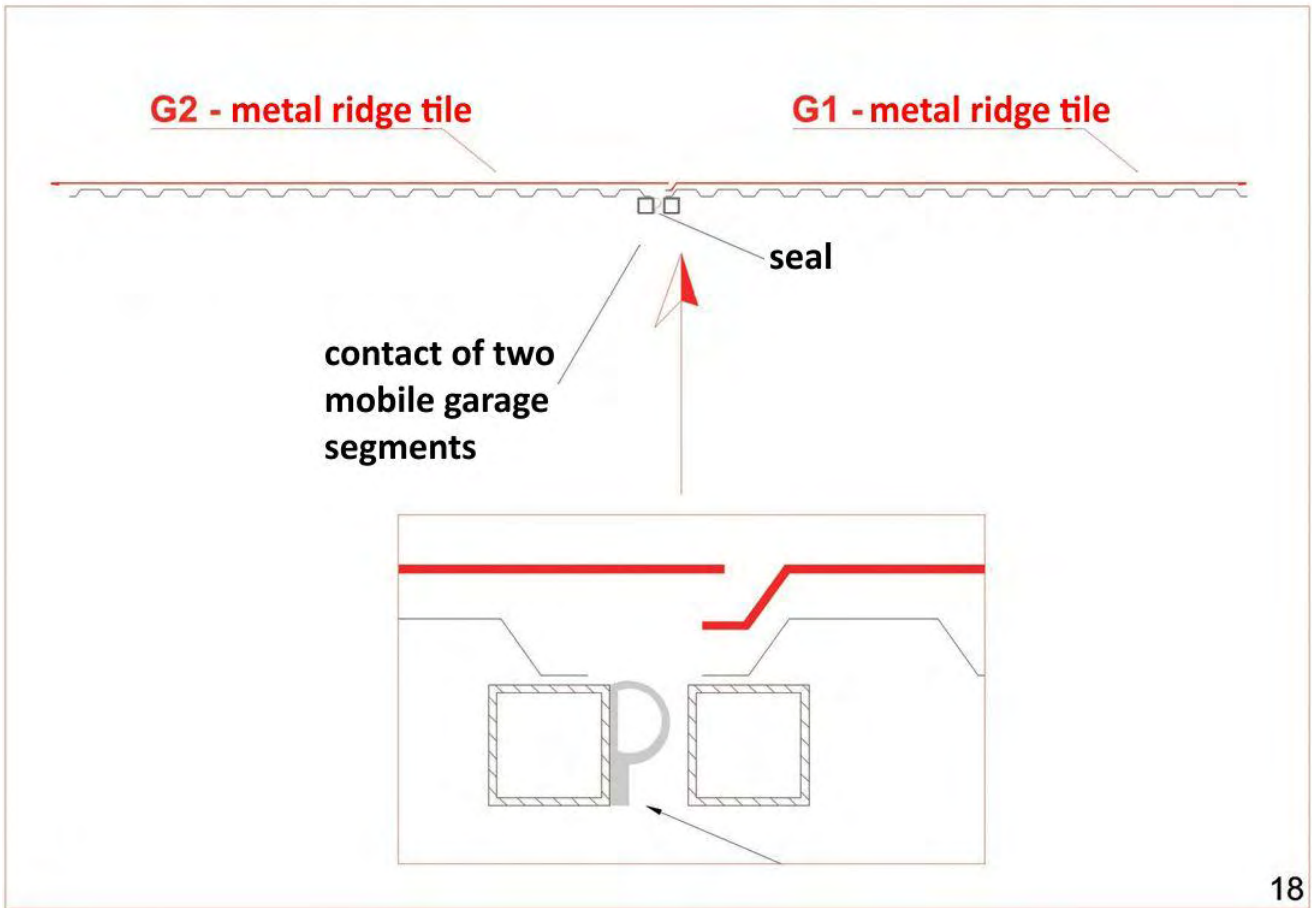

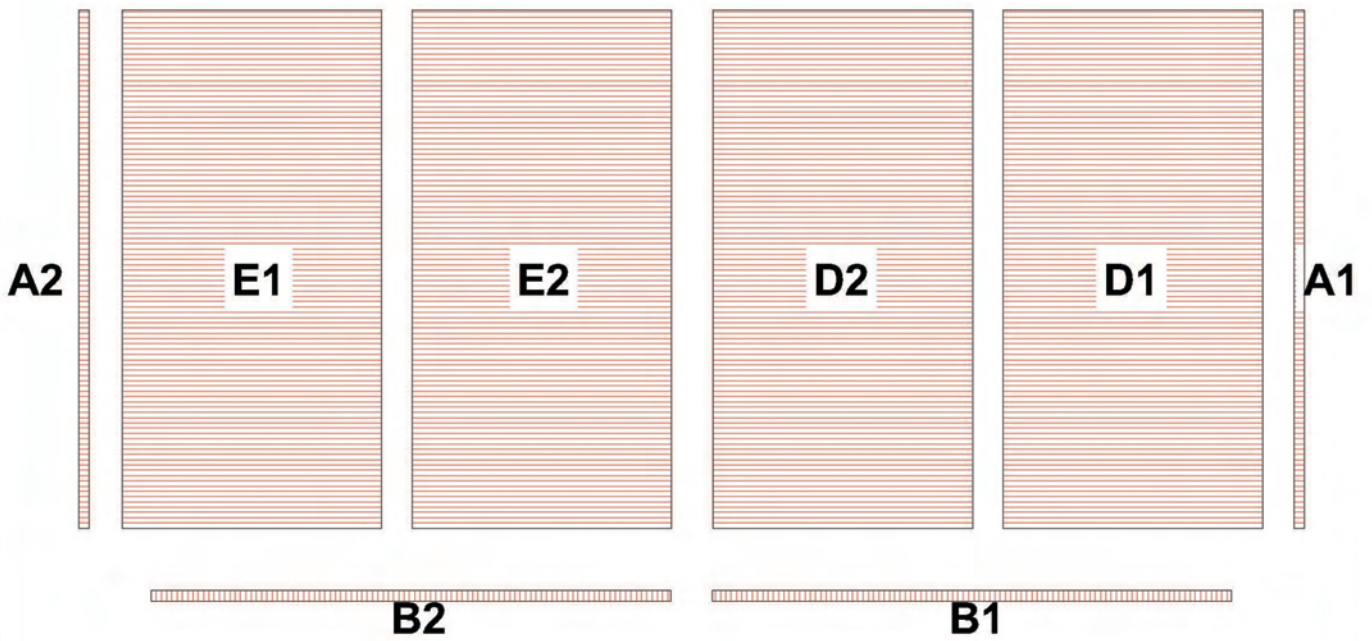
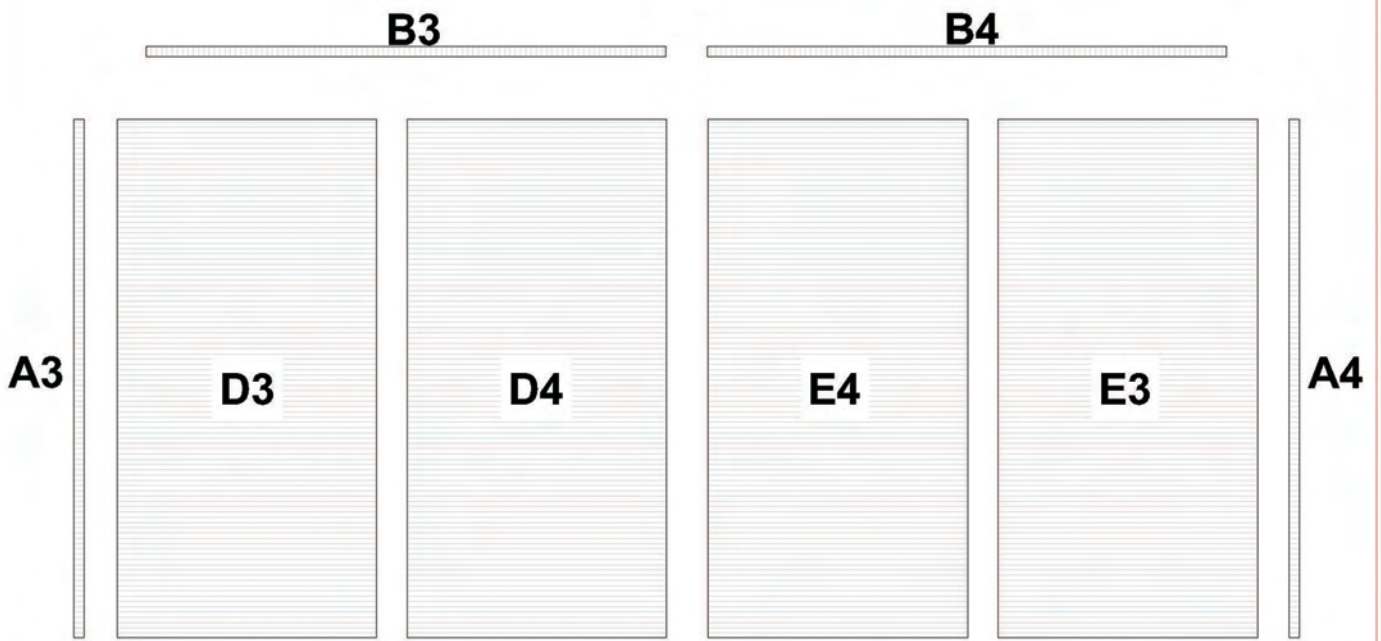

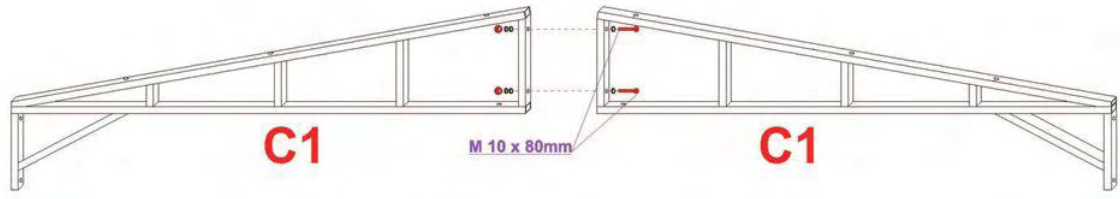

C1+C1=C
C = 2 pcs



C3=1 pc

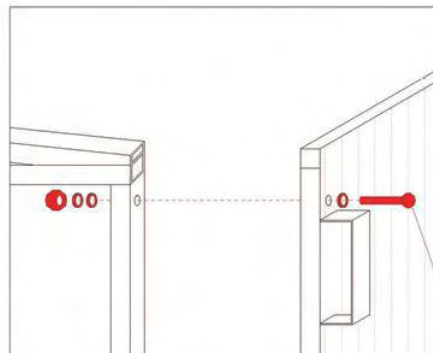

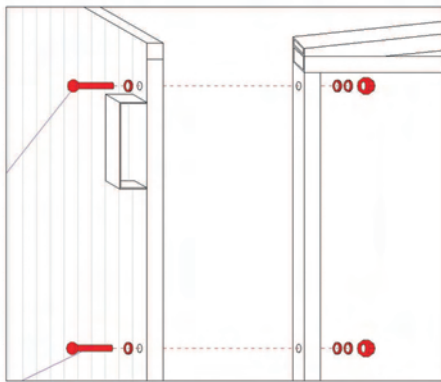
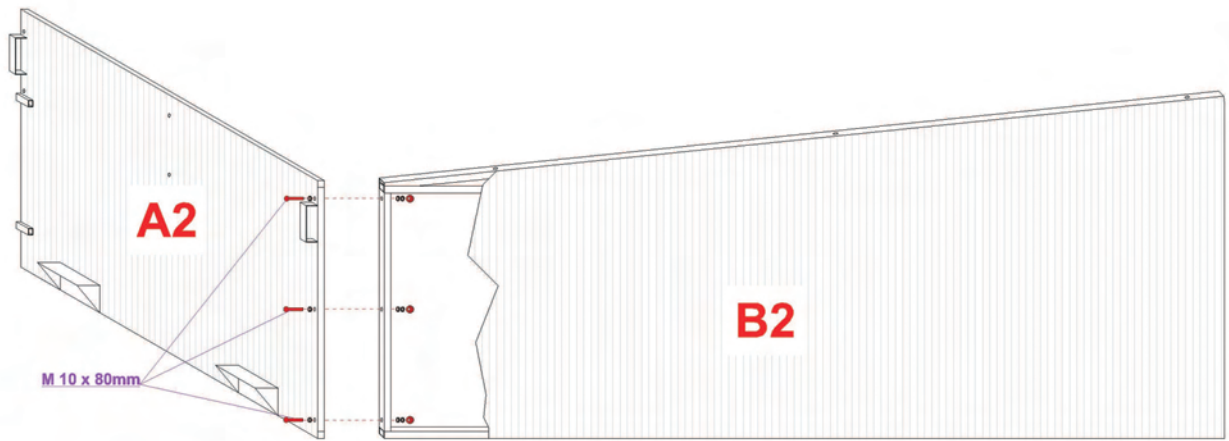

23

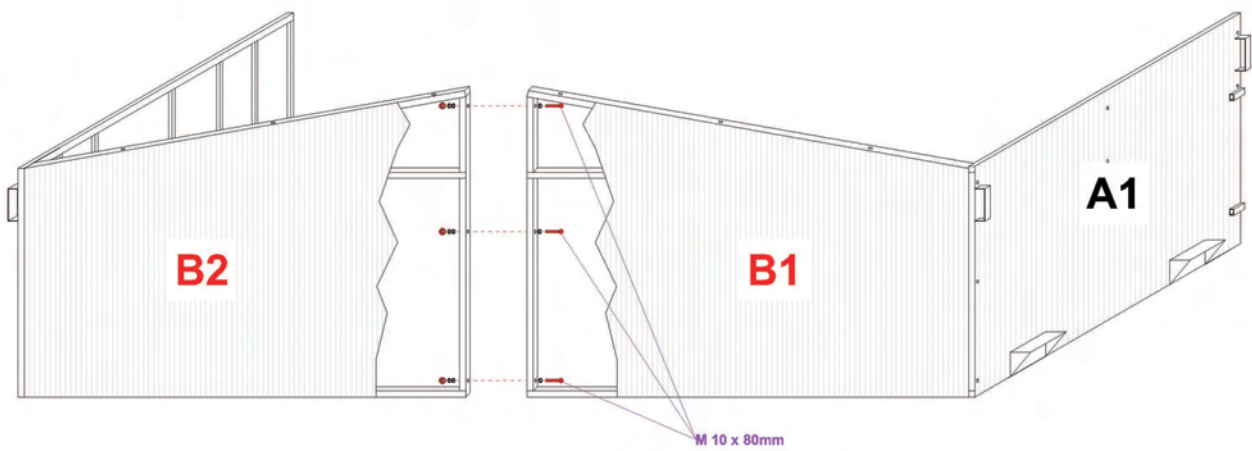

24

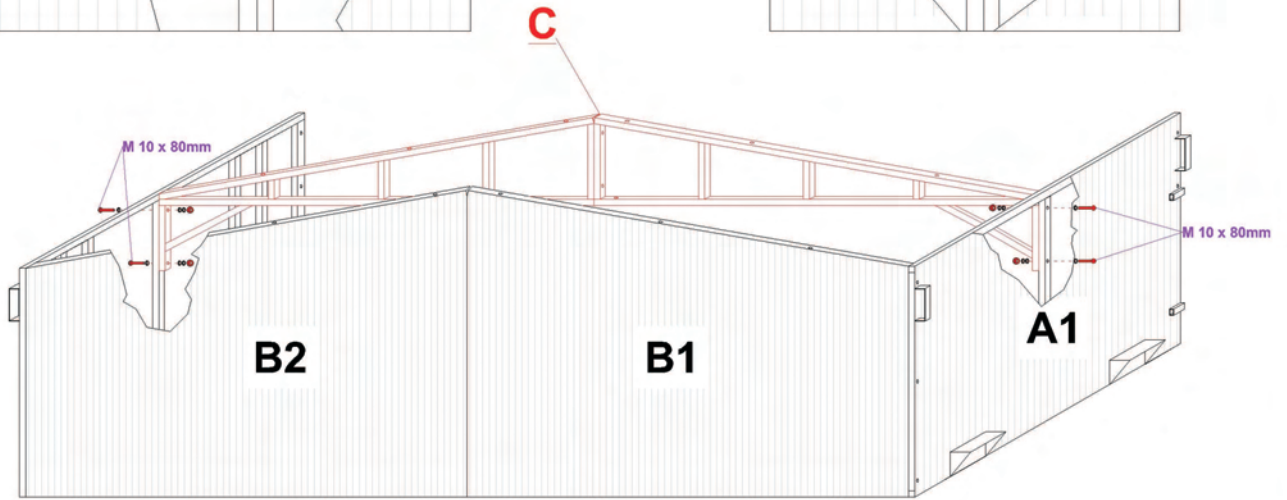
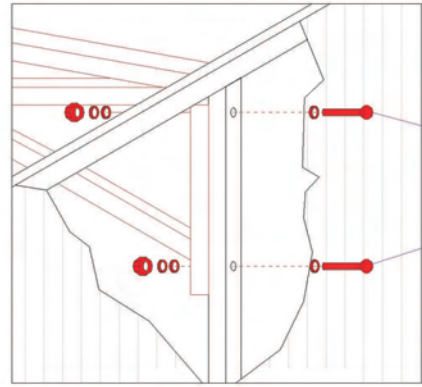
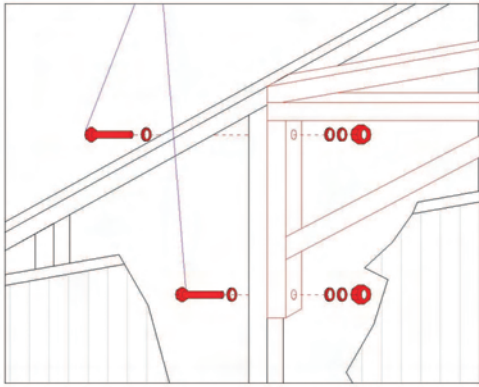

25

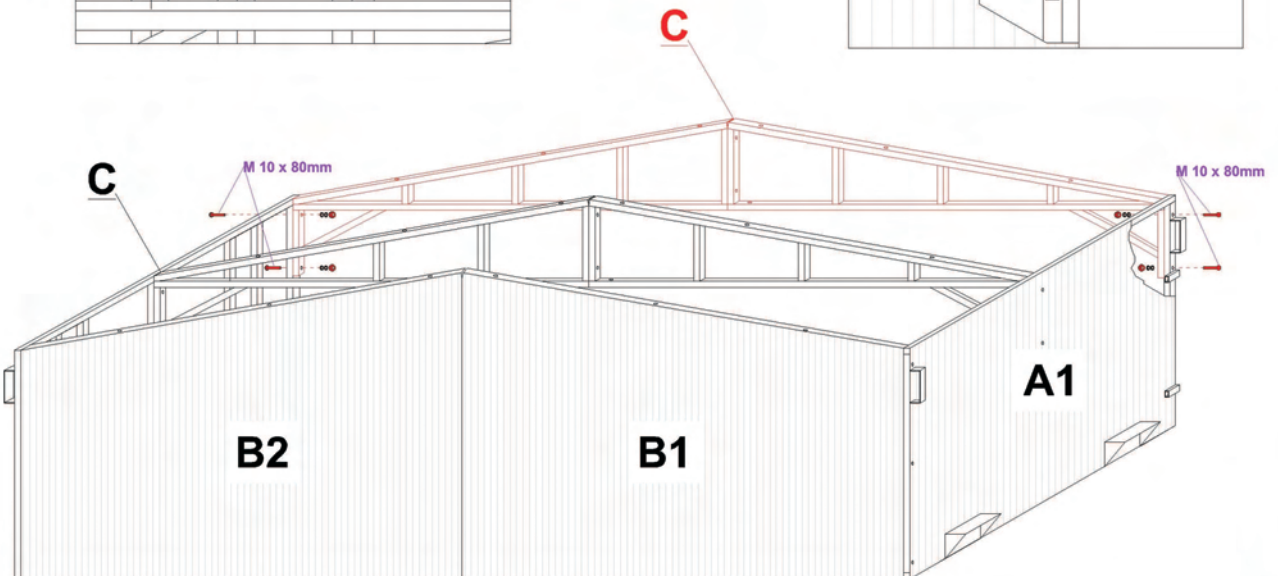
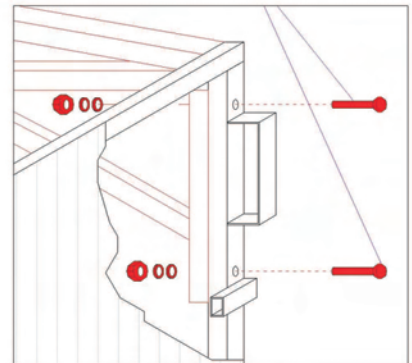
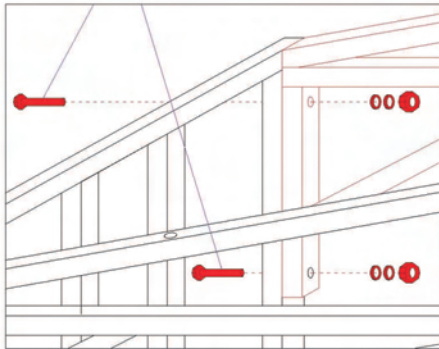

26

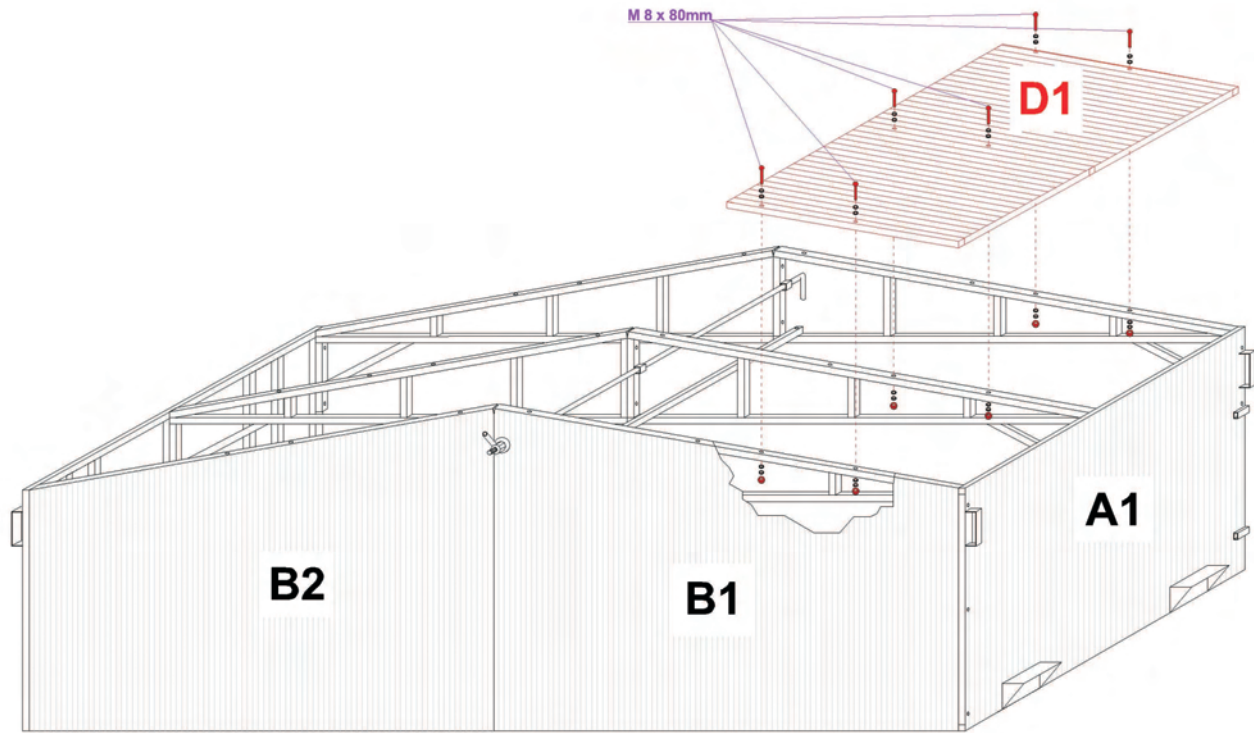

27

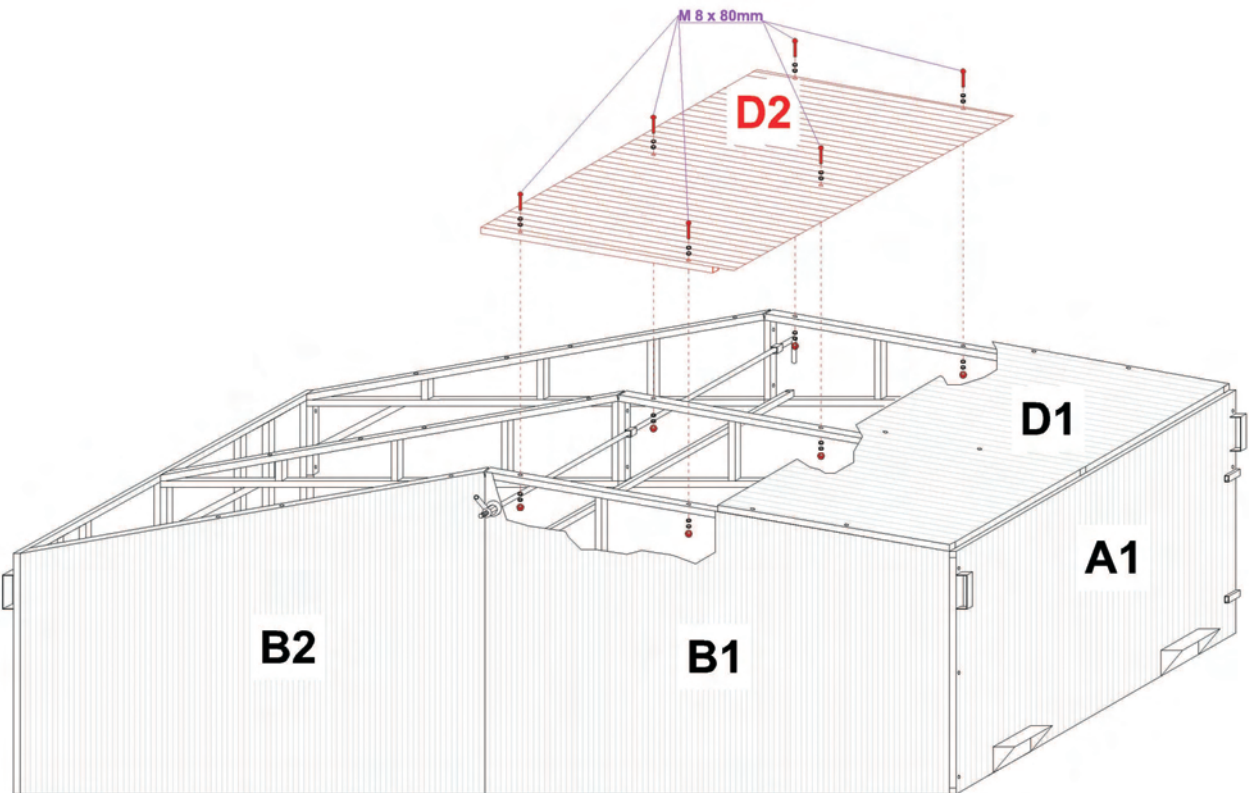

28

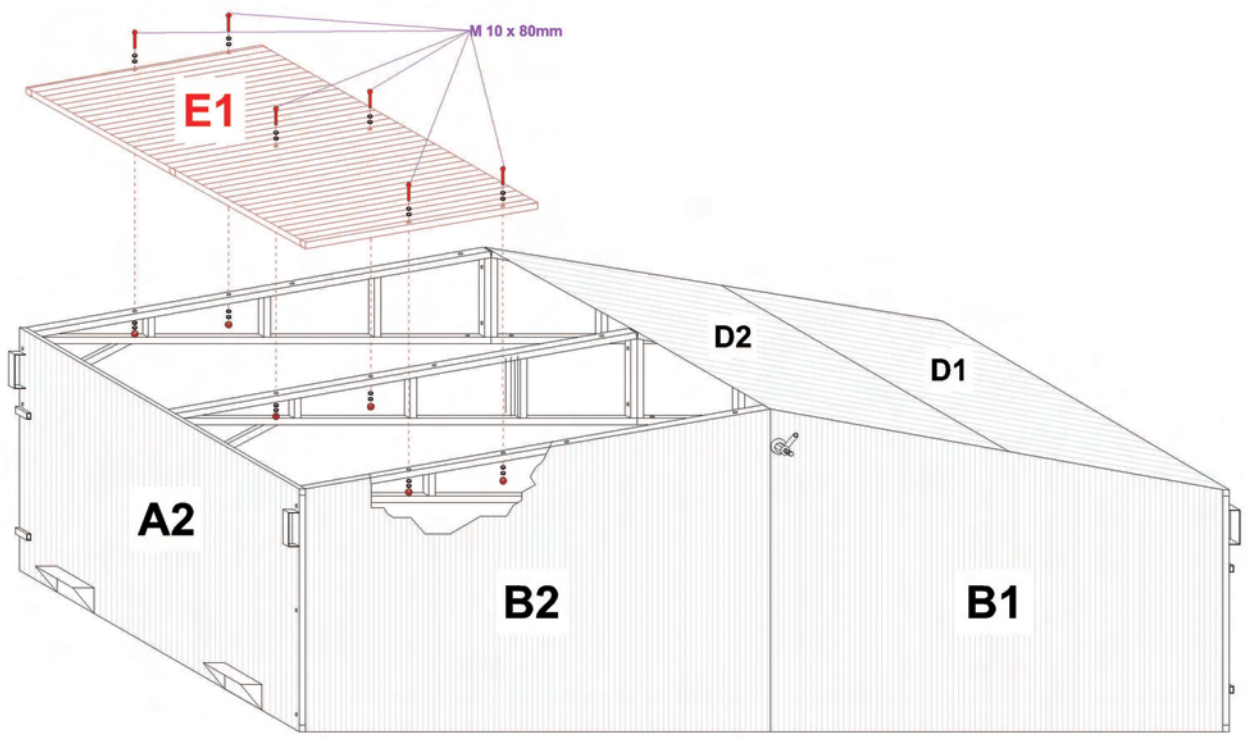
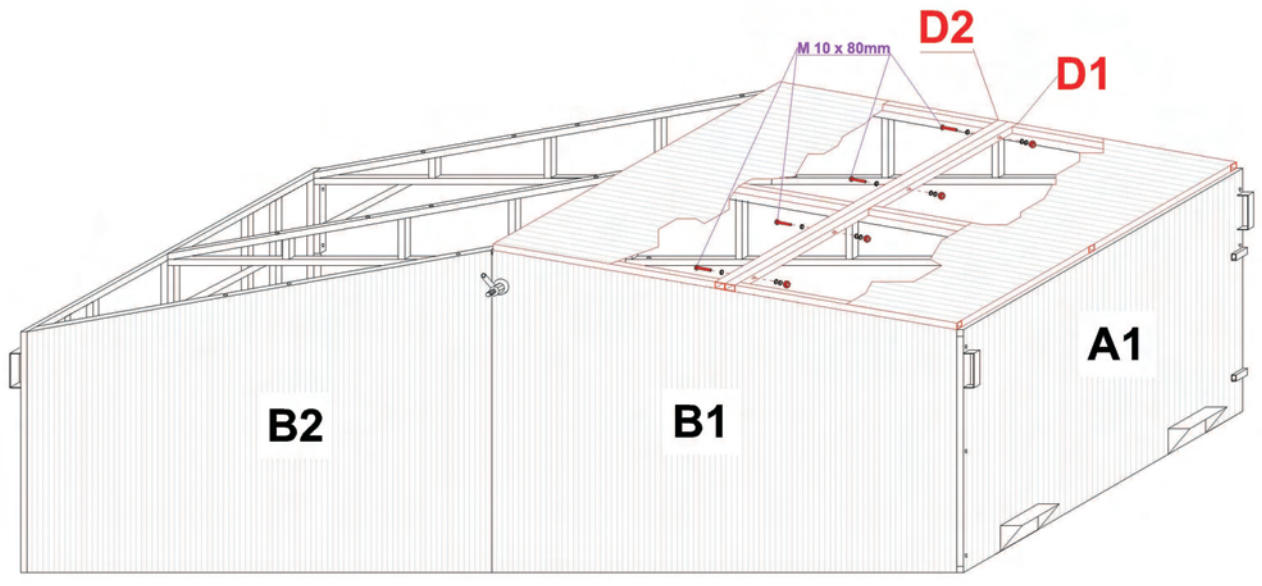

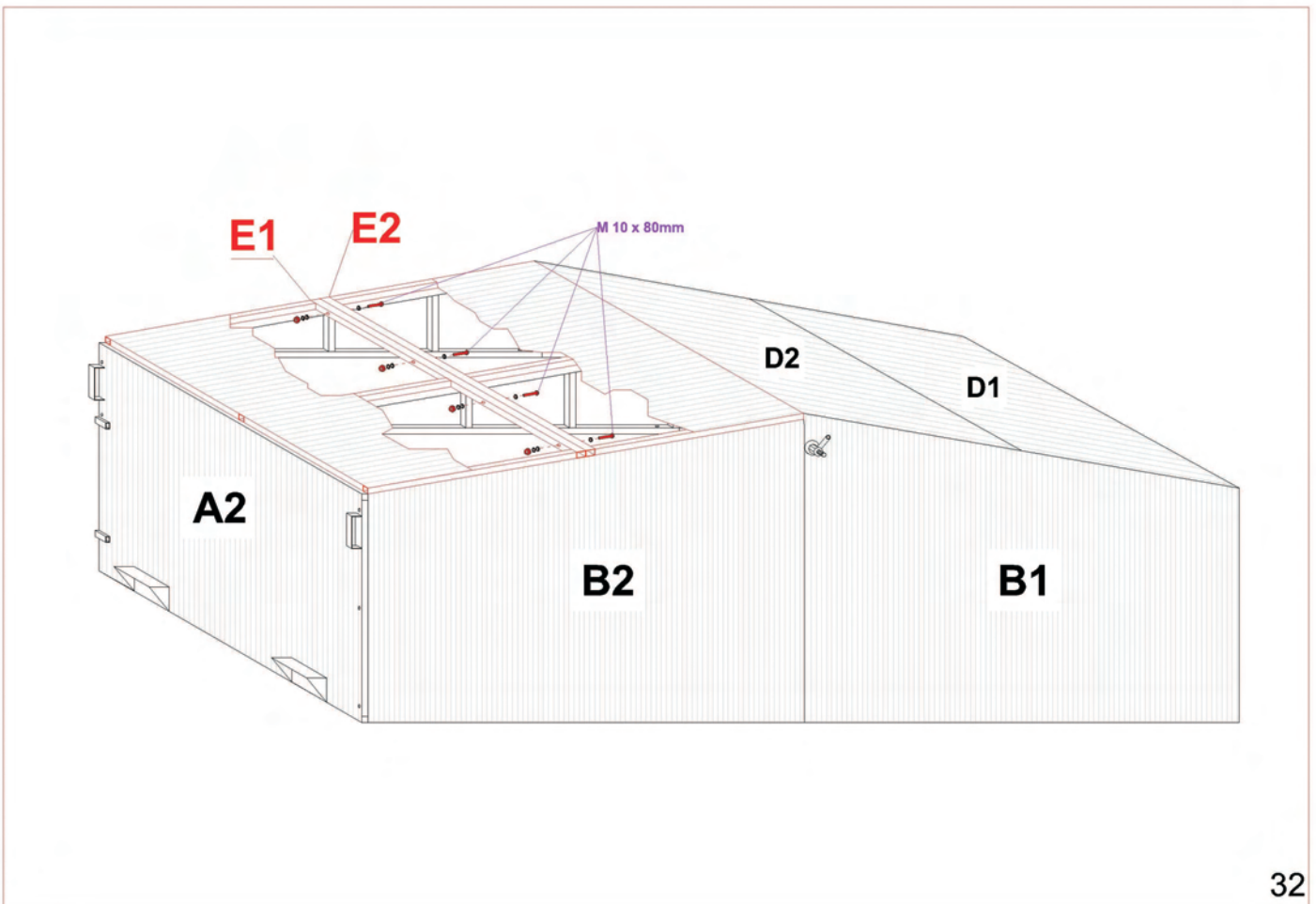
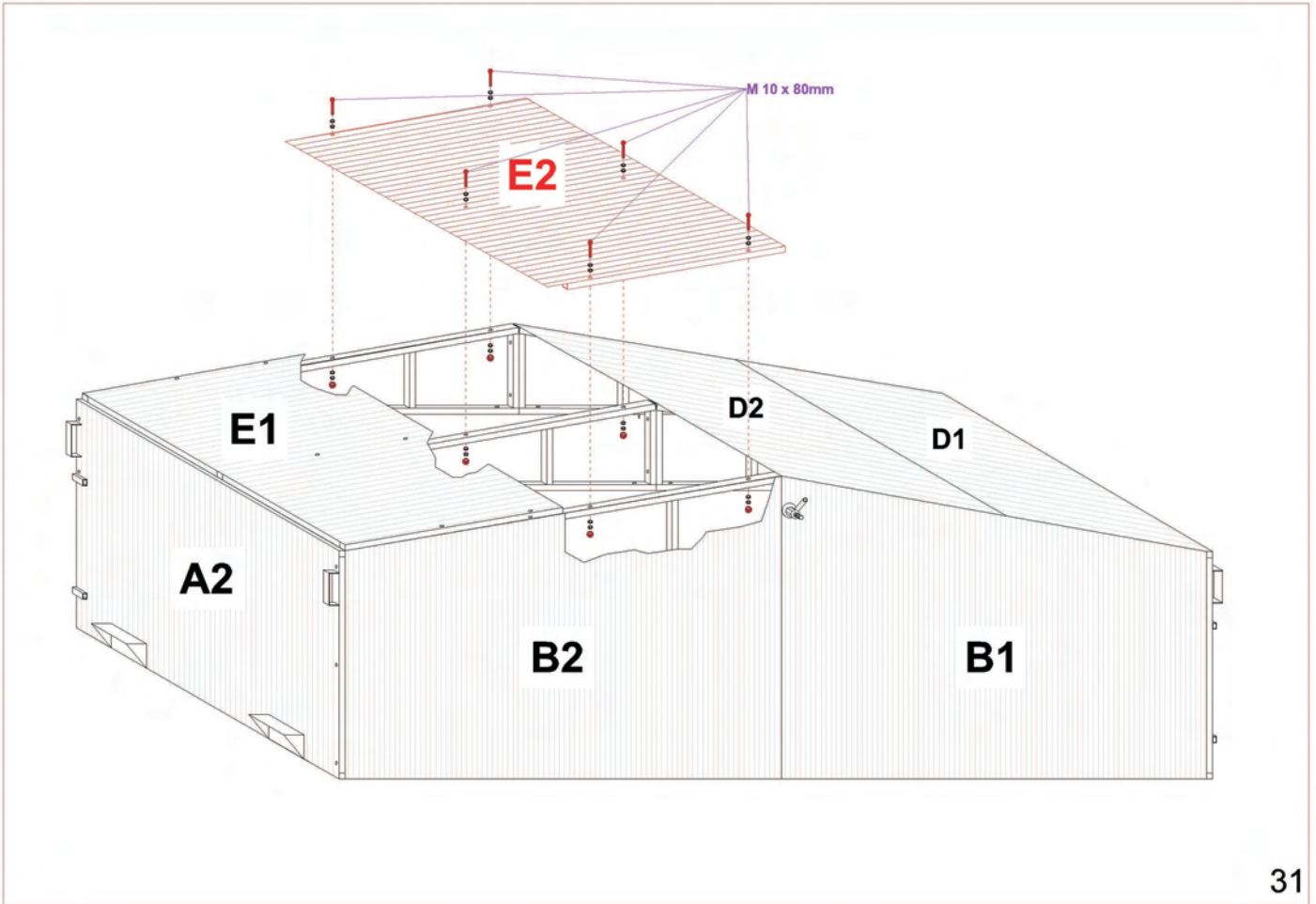

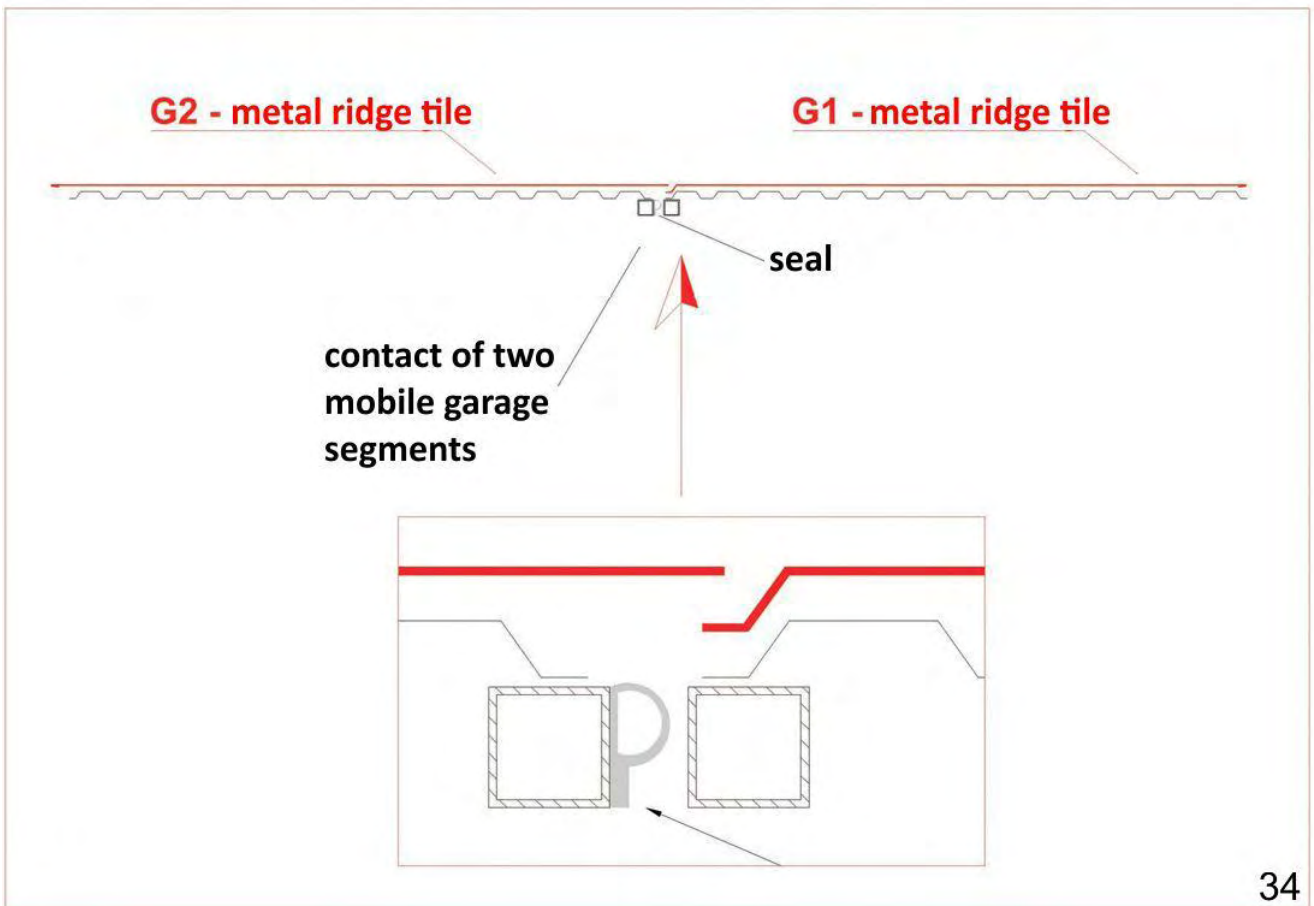
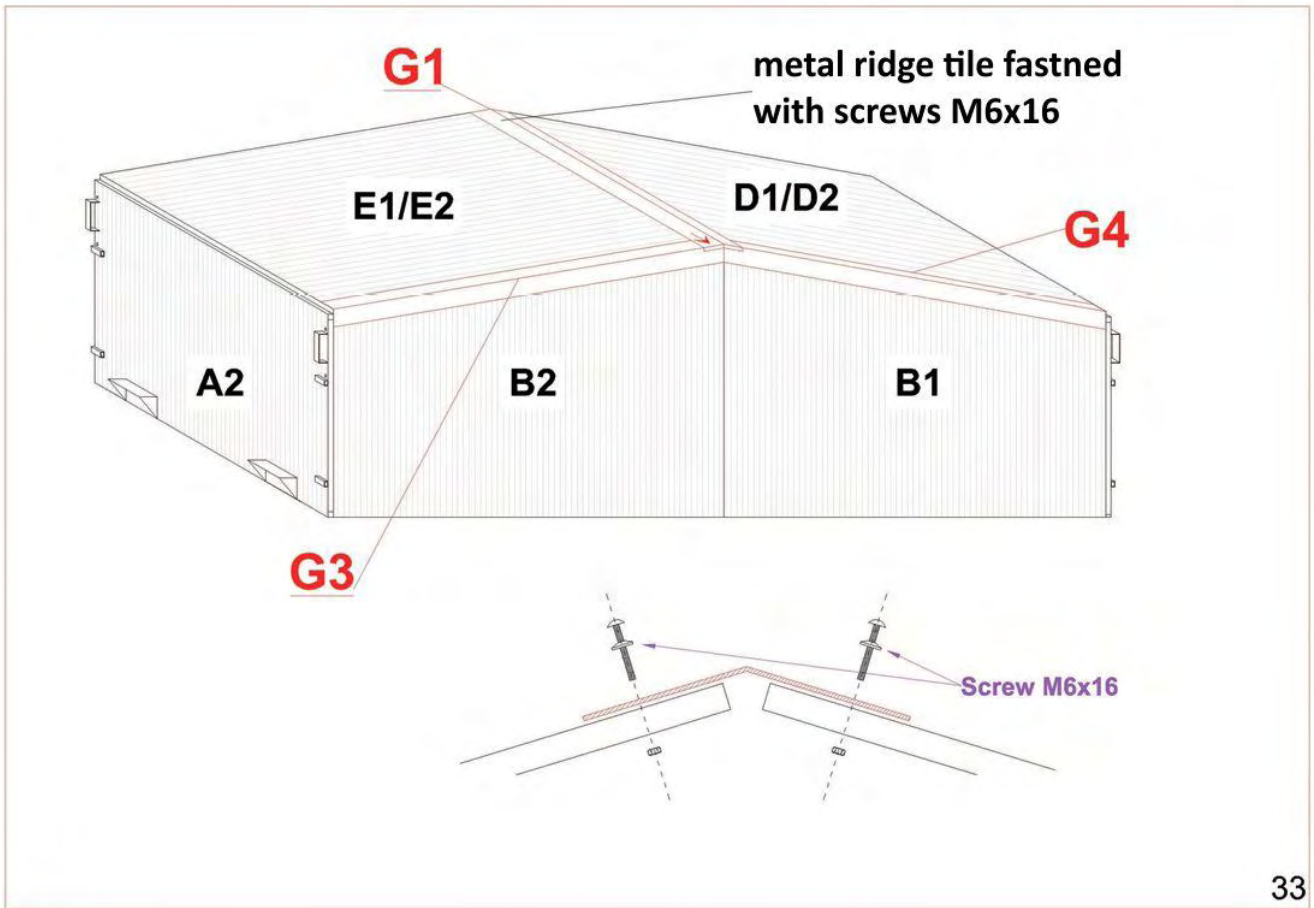

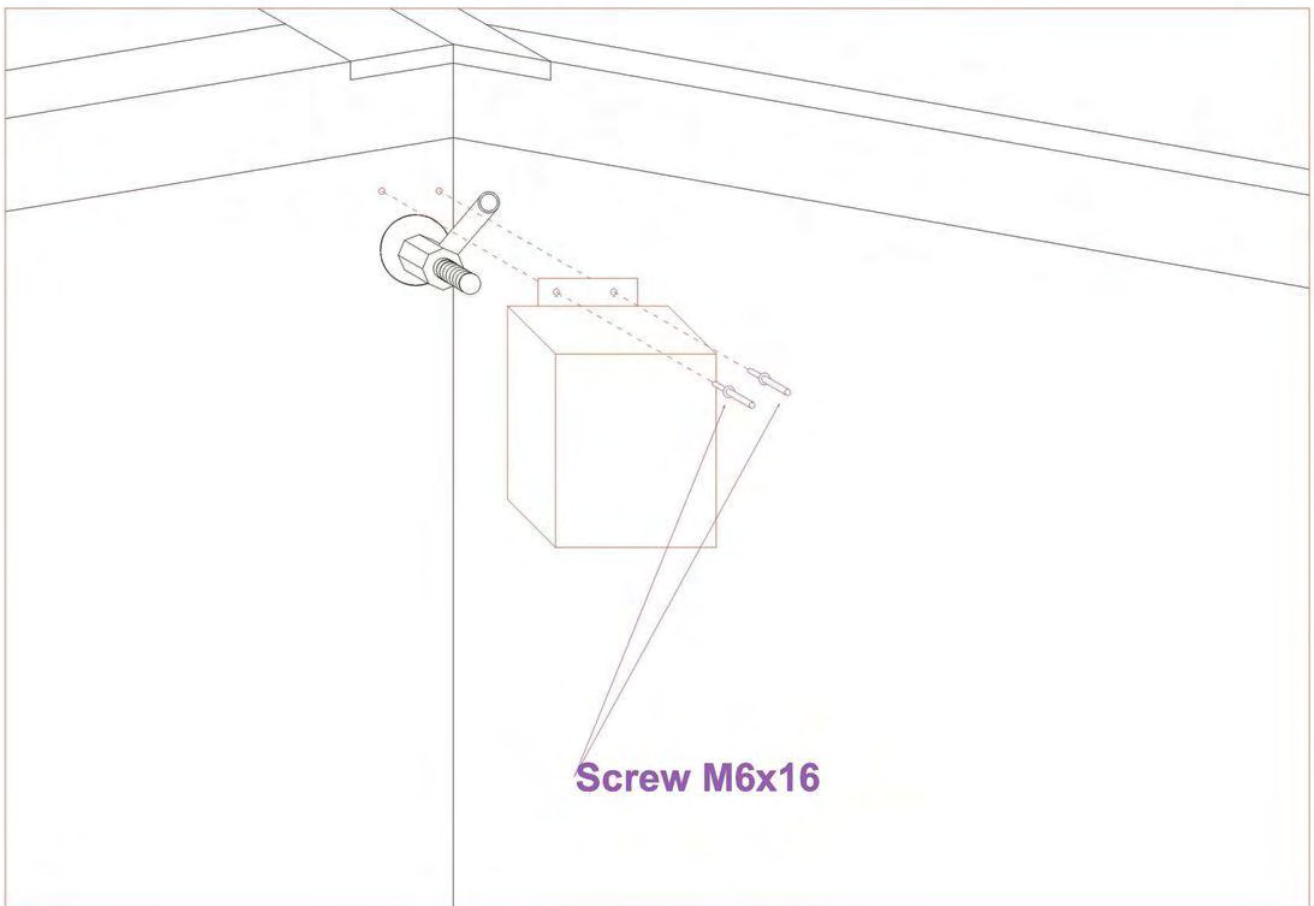
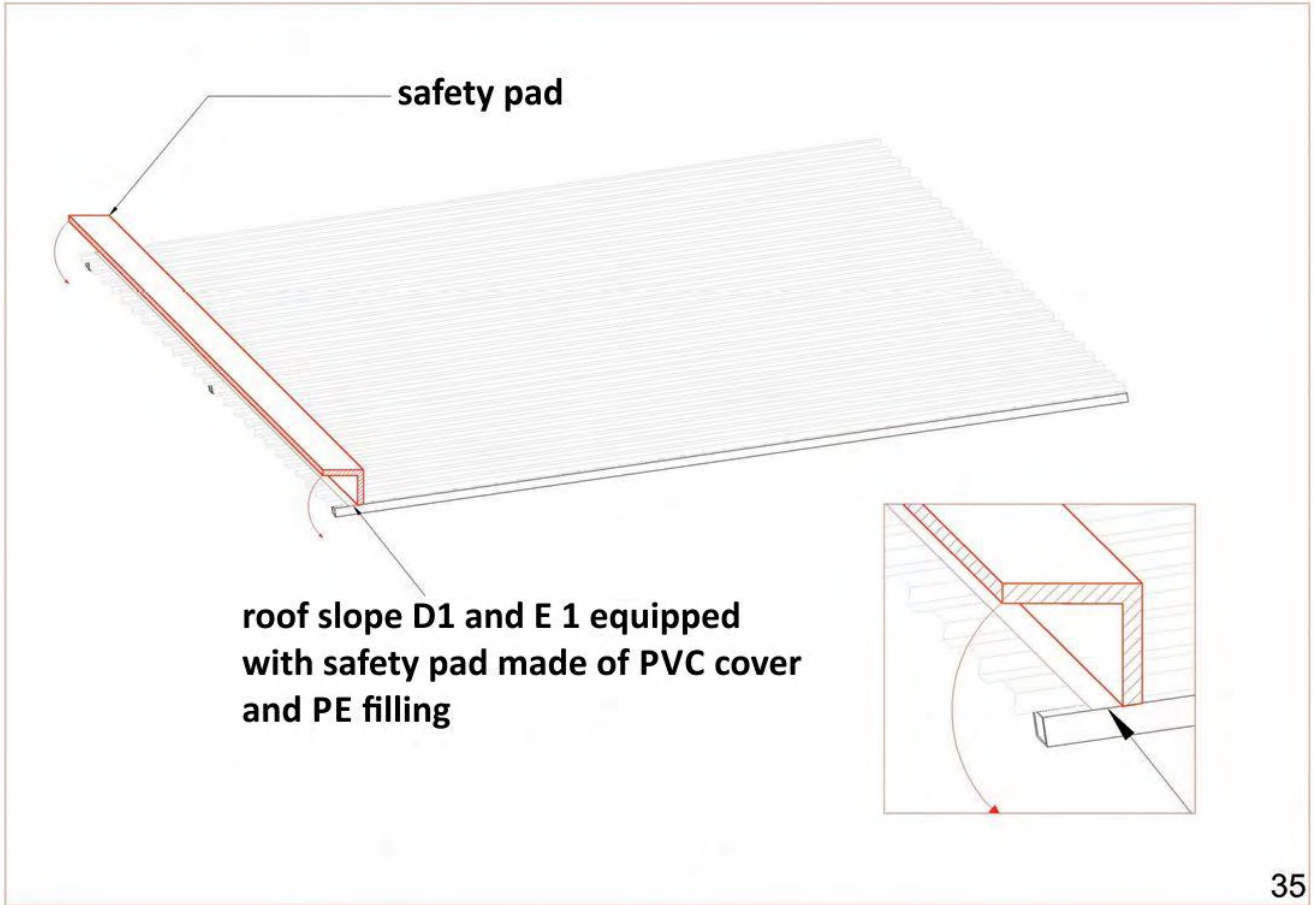

OPEN

UNSCREW

2

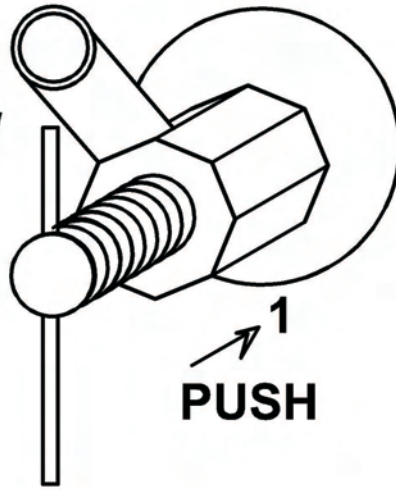

1
PUSH

CLOSE

SPIN

1

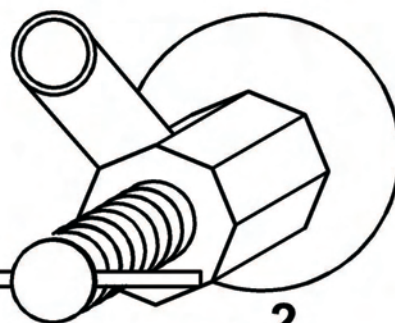

2
PULL